

CATALOGUE NOW ON-LINE

For the latest version of this catalogue go to our website at www.thewoodworks.com.au
Click on the Home Page link to the CATALOGUE PDF's

SCOPE OF THIS CATALOGUE

We sell in excess of 8,000 products. This catalogue lists a smaller selection of items which have proven popular with TAFE over many years. For other items please contact us or search our website at www.thewoodworks.com.au.

ACCOUNTS

We offer immediate terms to any Australian TAFE. No account opening procedures are needed.
All we ask is that orders are on official TAFE letterhead and have an Order Number

FIXED WRITTEN QUOTES

To speed up your admin time we can supply you with a written quote for any of our items.

HEGNER MACHINES - SALES & SERVICE

We are very proud of the service record of our Hegner machines many of which are still performing as new after 25 years in Australian schools & TAFE. We can use a metropolitan or national courier service to ship machines back to us for evaluation of you wish.
We will provide a repair quote and advise the current replacement cost of the machine to assist with your

For complete data sheets and more information on all products in this catalogue search using the ITEM CODE in the SEARCH box on the HOME PAGE at www.thewoodworks.com.au

INDEX

Index	1	Scroll Saws	15
Wood Trades Tools	2	Scroll Saw Coping Blades	16
Bench Chisels	3	ZFG Finger Jointer	18
Pliers	4	Vacuums	19
Chisels	4	Sanding Machines	19
Skew Chisels	6	Hand Plane Spares	20
Cranked Chisels	8	Threaded Inserts	21
Bench Gouges	8	Cabinet & Door Hardware	21
Patternmakers Chisels	8	Escutcheon Pins	22
Sash Mortice Chisels	9	Brass Wood Screws	23
Firmer Chisels	9	Brass Nuts & Bolts	26
Framing Chisels	9	Glues, Biscuits & Dowel	27
Corner Chisels	9	Putty Sticks	29
Slicks	9	Shellac	29
Drills, Forstner, Expanding Bits	10	Tung Oil, Wax	29
Doweling Jigs	11	Abrasives	29
Japanese Saws	12	Books	31
Marples layout Tools	13		

SPECIAL WOOD TRADES TOOLS

BUTT GAUGE

Return of a classic. All metal construction, chrome plated, dual scale, dual scribe butt gauge suited to setting out 'hinges and other hardware on windows and doors. 0~50mm and 0~2inch scale

	ITEM	RRP	Ex GST
✓ Gauge, Butt, Dual Scribe, Dual Scale	E2505	29.95	27.23



E2505

LATCH MATE

Unique Australian designed door latch recess punch and butt chisel tool. Punches out a perfect standard 1 x 2 1/4 inch recess for standard passage door latches. The integral chisel is right to hand to clear the waste & seat the latch set.

	ITEM	RRP	Ex GST
✓ Chisel, Lock Setting, 'LATCH MATE'	E2498	148.50	135.00



E2498

Alloy Body Block Planes - Razor Blade Style - Japanese Made

Stable and tough plane body with screw adjust blade feed. Blades are replaceable and offer excellent durability.

✓ Alloy Base, Jump, 170 x 56mm Overall, 45mm	T2995	92.11	83.73
✓ Alloy Base, Jump, 205 x 60mm Overall, 50mm	T2996	94.95	86.32
✓ Blade, for Jump 45mm Alloy Plane, pkt 5	T3500	34.79	31.62
✓ Blade, for Jump 50mm Alloy Plane, pkt 5	T3501	34.79	31.62



T2995 T2996

Cat's Paw & Splay, Nail set

✓ Shark Bar, 200mm (8 inch), #21-2220	T8026	59.80	54.36
✓ Shark Bar, 250mm (10 inch), #21-2225	T8027	62.20	56.55
✓ V Notched Splayed Pry Bar, 250mm (10 inch), #21-2325	T8028	63.40	57.64
✓ Cat's Paw / Nail Set, 150mm, Shark Bar, #21-2301	T8032	43.00	39.09



T8026

Cat's Paw & Nail Puller

✓ Japanese Style, Sharkgrip, 160mm, #21-2016	T8040	44.86	40.78
✓ Japanese Style, Sharkgrip, 200mm, #21-2020	T8041	50.80	46.18
✓ Japanese Style, Sharkgrip, 230mm, #21-2023	T8042	51.40	46.73
✓ Japanese Style, Sharkgrip, 260mm, #21-2026	T8043	59.40	54.00
✓ Japanese Style, Sharkgrip, 280mm, #21-2028	T8044	63.60	57.82
✓ Japanese Style, Sharkgrip, 300mm, #21-2030	T8045	71.00	64.55
✓ Japanese Style, Sharkgrip, 360mm, #21-2036	T8046	83.00	75.45



T8040 - T8046

Squaring Punch

Designed to square the corners when routing hinge or other hardware recesses. Align the device in the corner of the routed recess to be squared and tap the spring loaded chisel. Disassembles for sharpening.

	ITEM	RRP	Ex GST
✓ Chisel, Corner Cutting	E2490	19.90	18.09



E2490

Decking Drill / Countersink / Counterbore

Can be set up as a stopped drill, drill countersink and drill countersink counterbore. The stop stops rotating when it contacts the work and prevents marring.

✓ Bit, Countersink/bore, with Rotating Depth Stop, 4mm Drill	T0994	103.49	94.08
✓ Bit, Countersink/bore, with Rotating Depth Stop, 5mm Drill	T0995	103.49	94.08



T0994 - T0995

Hand Held Centering Punch

Centre pricks a guide hole for screws to minimise

✓ Punch, Centering, for Hinge Fitting, Overall 130mm	T0988	24.79	22.54
--	-------	-------	-------



T0988

Hinge Drilling Bit

Chuckable hinge drilling bit which provides a guide hole for screws to avoid grain following when screwing fasteners in

✓ Bit, Hinge Drilling, 'Zenterfix', 2.0mm, #706230	T0990	40.71	37.01
✓ Bit, Hinge Drilling, 'Zenterfix', 2.75mm, #706231	T0991	41.40	37.63
✓ Bit, Hinge Drilling, 'Zenterfix', 3.5mm, #706232	T0992	44.35	40.32



T0990

Cross Hole HSS Countersinks - Australian Made

Cross hole HSS countersinks offer the smoothest countersinking on the market.

✓ Countersink, Cross Hole, HSS, 82deg, 5 to 13mm	T0115	27.72	25.20
✓ Countersink, Cross Hole, HSS, 82deg, 4 to 10mm	T0116	27.72	25.20
✓ Countersink, Cross Hole, HSS, 82deg, 5 to 16mm	T0118	40.92	37.20
✓ Countersink, Cross Hole, HSS, 82deg, 8 to 20mm	T0119	58.08	52.80
✓ Countersink, Cross Hole, HSS, 82deg, 10 to 24mm	T0120	86.40	78.55



T0115

Tapered Plug Cutters

✓ Cutter, Plug, Tapered, 6mm, #701860	T0170	16.12	14.65
✓ Cutter, Plug, Tapered, 8mm, #701861	T0171	16.88	15.35
✓ Cutter, Plug, Tapered, 10mm, #701862	T0172	17.14	15.58
✓ Cutter, Plug, Tapered, 12mm, #701863	T0173	17.55	15.95
✓ Cutter, Plug, Tapered, 16mm, #701864	T0174	17.99	16.35



T0170 - T0174

Cabinet Scrapers - Austrian & French

✓ set of 4, 0.4mm thick, #703517	T1686	22.13	20.12
✓ set of 4, 0.6mm thick, #703518	T1687	23.24	21.13
✓ set of 4, 0.8mm thick, #703536	T1688	23.80	21.64
✓ 1.2mm, 140mm x 50mm, Rectangular Heavy Gauge	T1698	5.45	4.95
✓ 1.2mm, 160mm x 60mm, Rectangular Heavy Gauge	T1699	5.95	5.41



T1686 - T1699

Scrapers - Spanish Made

✓ Scraper, Paint, 35mm wide, #718220	T1744	26.95	24.50
✓ Scraper, Paint, 62mm wide, #718222	T1745	35.15	31.95



T1744 - T1745

✓ Scraper, Paint, Stubai, HANDLE ONLY, #449001	T1762	8.11	7.37
✓ Scraper, Paint, Stubai, Handle & Blade I and B, #449003	T1763	23.72	21.56
✓ Scraper, Paint, Stubai, Handle & Set of 12 Blade Profiles	T1764	111.46	101.32
✓ Scraper, Paint, Stubai, BLADE ONLY, Blade A, #448001	T1765	9.12	8.29
✓ Scraper, Paint, Stubai, BLADE ONLY, Blade B, #448002	T1766	7.34	6.67
✓ Scraper, Paint, Stubai, BLADE ONLY, Blade D, #448004	T1767	14.27	12.97
✓ Scraper, Paint, Stubai, BLADE ONLY, Blade E, #448005	T1768	14.27	12.97
✓ Scraper, Paint, Stubai, BLADE ONLY, Blade G, #448007	T1769	9.12	8.29
✓ Scraper, Paint, Stubai, BLADE ONLY, Blade H, #448008	T1770	9.12	8.29
✓ Scraper, Paint, Stubai, BLADE ONLY, Blade I, #448009	T1771	9.12	8.29
✓ Scraper, Paint, Stubai, BLADE ONLY, Blade K, #448011	T1772	9.12	8.29
✓ Scraper, Paint, Stubai, BLADE ONLY, Blade L, #448012	T1773	9.12	8.29
✓ Scraper, Paint, Stubai, BLADE ONLY, Blade M, #448013	T1774	14.27	12.97
✓ Scraper, Paint, Stubai, BLADE ONLY, Blade N, #448014	T1775	14.27	12.97
✓ Scraper, Paint, Stubai, BLADE ONLY, Blade P, #448015	T1776	9.12	8.29



T1763

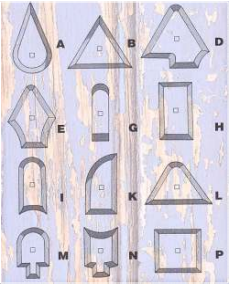

Shave Hooks - German Made

✓ Hook, Shave, 2.5mm x 60mm Triangular, #1765	T1680	16.02	14.57
✓ Hook, Shave, 2.5mm x nom. 80mm Tear Drop, #1766	T1681	17.68	16.07

Roofing Hammer with Nail Starter - French Made

✓ Checkered Face, Overall 315mm, 600g, Elastomer Handle	T4355	76.61	69.64
✓ Plain Face, Overall 315mm, 700g, Leather Handled	T4356	134.21	122.01



T4355

Compass Dividers - Austrian Made

✓ with Pencil Holder, 200mm, Stubai, #252002	T4480	62.44	56.76
✓ with Pencil Holder, 250mm, Stubai, #252003	T4481	71.27	64.79

Pincers - Polished Head - Coated Handles - Austrian Made

✓ 130mm, #107902	T7993	26.19	23.81
✓ 160mm, #107903	T7994	25.53	23.21
✓ 180mm, #107904	T7995	26.69	24.27
✓ 200mm, #107905	T7996	27.17	24.70
✓ 225mm, #107906	T7997	30.00	27.27
✓ 250mm, #107907	T7998	34.06	30.96
✓ HEAVY DUTY, 130mm, #108004	T7999	52.39	47.63

T7993 - T7999

T4480 - T4481

T1681



Soft Jaw Pliers & Special Pliers - Japanese Made

Soft jaw pliers have numerous applications across numerous trades from door hangers who need to grip door hardware without scratching finishes to plumbers who need the same ability with taps.

✓ Multigrip, Soft Jaw, with Square & Round Jaws, to 70mm	T7880	68.81	62.56
✓ Multigrip, Plumbers, Soft Jaw, Capacity 6~50mm	T7884	48.74	44.31
✓ Combination, Soft Jaw	T7886	26.70	24.27
✓ Long Nose, Soft Jaw	T7887	26.70	24.27
✓ Pliers, Nose Grip	T7890	59.42	54.02



BENCH CHISELS

A 'bench' chisel is a term to specify the style of general purpose woodworking chisels used in the majority of woodworking pursuits. The bevel edge bench chisel has become the most widespread style supplanting in popularity the rectangular section 'firmer' chisel, a dominant design of earlier generations.

Many chisel brands with long established names and reputations in western markets are now made entirely, or in part, in east Asia and are not the quality they once were. These reputable brands are frequently passed off as "Swedish" or "British" made and can be marketed as so because of slack truth-in-labelling laws now common in many countries.

Stubai continue to manufacture their chisels in Austria from Austrian or German steel stock. They offer two alternative steel compositions, their DIN standard and their in-house proprietary 'spezial' tool steel. This means you have a choice of excellent or supreme. The 'spezial' blades from Stubai routinely win when western chisels are assessed in bench chisel reviews.

The Wood Works import directly from the factory which means remarkably good value. Each pattern, with the exception of the #3575, is available individually and in sets. The #3575 are available individually.

#3530 'SWEDISH' SERIES

The top of the range for Stubai. Called their Swedish range in deference to E.A.Berg, the revered manufacturer from earlier times.

These have the top of the range 'spezial' steel, shock washer and a hoop & ferrule, white beech handle.

The Stubai 'spezial' alloy chisels regularly win competitive tests of all European and British makes. All chisels supplied with tip guards.



	ITEM	RRP	Ex GST
✓ 4mm, #353001	T9390	34.03	30.93
✓ 6mm, #353002	T9391	34.03	30.93
✓ 8mm, #353003	T9392	34.03	30.93
✓ 10mm, #353004	T9393	34.03	30.93
✓ 12mm, #353022	T9394	34.03	30.93
✓ 13mm, #353005	T9395	34.03	30.93
✓ 14mm, #353024	T9396	34.03	30.93
✓ 16mm, #353006	T9397	34.03	30.93
✓ 18mm, #353007	T9398	39.70	36.09
✓ 20mm, #353008	T9399	39.70	36.09
✓ 22mm, #353026	T9400	44.74	40.67
✓ 24mm, #353009	T9401	44.74	40.67
✓ 26mm, #353010	T9402	44.74	40.67
✓ 28mm, #353028	T9403	51.04	46.40
✓ 30mm, #353011	T9404	51.04	46.40
✓ 32mm, #353030	T9405	59.95	54.50
✓ 35mm, #353012	T9406	62.95	57.23
✓ 40mm, #353013	T9407	68.95	62.68
✓ Set of 6,10,13,16,20,26mm	T9408	199.95	181.77

#3550 TRADE SERIES

The all purpose trades range for Stubai. Fitted with tough acetate handles which will stand up to steel hammer blows. These have the top 'spezial' alloy steel. All chisels supplied with tip guards.



	ITEM	RRP	Ex GST
✓ 4mm, #355001	T9430	39.59	35.99
✓ 6mm, #355002	T9431	39.59	35.99
✓ 8mm, #355003	T9432	39.71	36.10
✓ 10mm, #355004	T9433	39.59	35.99
✓ 12mm, #355022	T9434	43.25	39.32
✓ 13mm, #355005	T9435	42.42	38.56
✓ 14mm, #355024	T9436	44.07	40.07
✓ 16mm, #355006	T9437	46.55	42.32
✓ 18mm, #355007	T9438	47.44	43.12
✓ 20mm, #355008	T9439	49.44	44.95
✓ 22mm, #355026	T9440	49.15	44.68
✓ 24mm, #355009	T9441	47.44	43.12
✓ 26mm, #355010	T9442	49.44	44.95
✓ 28mm, #355028	T9443	48.44	44.04
✓ 30mm, #355011	T9444	53.28	48.43
✓ 32mm, #355030	T9445	59.59	54.17
✓ 35mm, #355012	T9446	62.89	57.18
✓ Set of 6, 6,10,13,16,20,26mm	T9447	199.95	181.77

#3560 BI-MATERIAL HANDLE SERIES

Stubai's bi-material handle chisels with interchangeable coloured O rings at the rear of the handle. These have the top 'spezial' alloy steel. All chisels supplied with tip guards.



	ITEM	RRP	Ex GST
✓ 4mm, #356004	T9469	39.29	35.72
✓ 6mm, #356006	T9470	39.00	35.45
✓ 8mm, #356008	T9471	39.12	35.56
✓ 10mm, #356010	T9472	39.00	35.45
✓ 12mm, #356012	T9473	42.60	38.73
✓ 13mm, #356013	T9474	40.30	36.63
✓ 14mm, #356014	T9475	43.42	39.48
✓ 16mm, #356016	T9476	41.83	38.03
✓ 18mm, #356018	T9477	43.96	39.96
✓ 20mm, #356020	T9478	45.90	41.73
✓ 22mm, #356022	T9479	48.44	44.04
✓ 24mm, #356024	T9480	46.73	42.48
✓ 25mm, #356025	T9481	47.50	43.18
✓ 28mm, #356028	T9483	47.73	43.39
✓ 30mm, #356030	T9484	52.45	47.68
✓ 32mm, #356032	T9485	58.94	53.58
✓ 35mm, #356035	T9486	62.19	56.53
✓ Set of 6, 6.10.14.18.22.26mm, #356106	T9487	199.95	181.77

#3543 BLACK POLY PROPOLENE HANDLE SERIES

Stubai's poly pros have an extremely tough handle and DIN standard steel. These are preferred by educational institutions. All chisels supplied with tip guards.



	ITEM	RRP	Ex GST
✓ 2mm, #354302	T9449	26.95	24.50
✓ 4mm, #354304	T9450	21.83	19.85
✓ 6mm, (6), #354306	T9451	21.83	19.85
✓ 8mm, #354308	T9452	21.83	19.85
✓ 10mm, (6), #354310	T9453	21.83	19.85
✓ 12mm, (4), #354312	T9454	21.83	19.85
✓ 14mm, (6), #354314	T9455	21.83	19.85
✓ 16mm, (4), #354316	T9456	22.61	20.55
✓ 18mm, (6), #354318	T9457	23.60	21.45
✓ 20mm, (4), #354320	T9458	24.01	21.83
✓ 22mm, (6), #354322	T9459	24.95	22.68
✓ 24mm, (4), #354324	T9460	24.95	22.68
✓ 25mm, (4), #354325	T9461	24.95	22.68
✓ 26mm, (6), #354326	T9462	24.95	22.68
✓ 28mm, #354328	T9463	25.47	23.15
✓ 30mm, #354330	T9464	25.47	23.15
✓ 32mm, #354332	T9465	25.99	23.63
✓ 35mm, #354335	T9466	27.14	24.67
✓ 40mm, #354340	T9467	29.73	27.02
✓ Set of 6, 6, 10, 14, 18, 22, 26mm, #354406	T9468	129.95	118.14

SKEW GROUND PAIRS

We supply skew ground pairs of each size and pattern as listed above. A skewed tip assists with joint paring.



	ITEM	RRP	Ex GST
✓ Stubai, 4mm, Series #3530	T9610	119.84	108.95
✓ Stubai, 6mm, Series #3530	T9611	119.00	108.18
✓ Stubai, 8mm, Series #3530	T9612	119.00	108.18
✓ Stubai, 10mm, Series #3530	T9613	118.39	107.63
✓ Stubai, 12mm, Series #3530	T9614	123.34	112.13
✓ Stubai, 14mm, Series #3530	T9615	120.60	109.64
✓ Stubai, 16mm, Series #3530	T9616	124.03	112.75
✓ Stubai, 18mm, Series #3530	T9617	120.91	109.91
✓ Stubai, 20mm, Series #3530	T9618	124.26	112.96
✓ Stubai, 22mm, Series #3530	T9619	124.26	112.96
✓ Stubai, 24mm, Series #3530	T9620	126.23	114.76
✓ Stubai, 26mm, Series #3530	T9621	131.87	119.88
✓ Stubai, 28mm, Series #3530	T9622	131.41	119.47
✓ Stubai, 30mm, Series #3530	T9623	132.78	120.71
✓ Stubai, 32mm, Series #3530	T9624	140.39	127.63
✓ Stubai, 35mm, Series #3530	T9625	140.47	127.70
✓ Stubai, 40mm, Series #3530	T9626	152.04	138.22

#3550 SKEWED PAIRS

- ✓ Stubai, 4mm, Series #3550
- ✓ Stubai, 6mm, Series #3550
- ✓ Stubai, 8mm, Series #3550
- ✓ Stubai, 10mm, Series #3550
- ✓ Stubai, 12mm, Series #3550
- ✓ Stubai, 13mm, Series #3550
- ✓ Stubai, 14mm, Series #3550
- ✓ Stubai, 16mm, Series #3550
- ✓ Stubai, 18mm, Series #3550
- ✓ Stubai, 20mm, Series #3550
- ✓ Stubai, 22mm, Series #3550
- ✓ Stubai, 24mm, Series #3550
- ✓ Stubai, 26mm, Series #3550
- ✓ Stubai, 28mm, Series #3550
- ✓ Stubai, 30mm, Series #3550
- ✓ Stubai, 32mm, Series #3550
- ✓ Stubai, 35mm, Series #3550

ITEM	RRP	Ex GST
T9628	126.08	114.62
T9629	126.08	114.62
T9630	126.23	114.76
T9631	126.08	114.62
T9632	130.80	118.91
T9633	130.80	118.91
T9634	129.74	117.94
T9635	131.87	119.88
T9636	135.07	122.79
T9637	136.21	123.83
T9638	136.21	123.83
T9639	138.80	126.18
T9640	138.42	125.83
T9641	136.21	123.83
T9642	138.80	126.18
T9643	137.50	125.00
T9644	143.74	130.68

#3543 SKEWED PAIRS

- ✓ Stubai, 4mm, Series #3543
- ✓ Stubai, 6mm, Series #3543
- ✓ Stubai, 8mm, Series #3543
- ✓ Stubai, 10mm, Series #3543
- ✓ Stubai, 12mm, Series #3543
- ✓ Stubai, 13mm, Series #3543
- ✓ Stubai, 14mm, Series #3543
- ✓ Stubai, 16mm, Series #3543
- ✓ Stubai, 18mm, Series #3543
- ✓ Stubai, 20mm, Series #3543
- ✓ Stubai, 22mm, Series #3543
- ✓ Stubai, 24mm, Series #3543
- ✓ Stubai, 25mm, Series #3543
- ✓ Stubai, 26mm, Series #3543
- ✓ Stubai, 28mm, Series #3543
- ✓ Stubai, 30mm, Series #3543
- ✓ Stubai, 32mm, Series #3543
- ✓ Stubai, 35mm, Series #3543
- ✓ Stubai, 40mm, Series #3543

ITEM	RRP	Ex GST
T9645	111.27	101.15
T9646	106.87	97.15
T9647	106.00	96.36
T9648	105.07	95.52
T9649	105.07	95.52
T9650	106.00	96.36
T9651	106.60	96.91
T9652	107.20	97.45
T9653	108.60	98.73
T9654	109.20	99.27
T9655	110.67	100.61
T9656	110.07	100.06
T9657	110.07	100.06
T9658	110.07	100.06
T9659	110.07	100.06
T9660	110.73	100.67
T9661	110.87	100.79
T9662	112.27	102.06
T9663	112.27	102.06

#3560 SKEWED PAIRS

- ✓ Stubai, 4mm, Series #3560
- ✓ Stubai, 6mm, Series #3560
- ✓ Stubai, 8mm, Series #3560
- ✓ Stubai, 10mm, Series #3560
- ✓ Stubai, 12mm, Series #3560
- ✓ Stubai, 13mm, Series #3560
- ✓ Stubai, 14mm, Series #3560
- ✓ Stubai, 16mm, Series #3560
- ✓ Stubai, 18mm, Series #3560
- ✓ Stubai, 20mm, Series #3560
- ✓ Stubai, 22mm, Series #3560
- ✓ Stubai, 24mm, Series #3560
- ✓ Stubai, 25mm, Series #3560
- ✓ Stubai, 26mm, Series #3560
- ✓ Stubai, 28mm, Series #3560
- ✓ Stubai, 30mm, Series #3560
- ✓ Stubai, 32mm, Series #3560
- ✓ Stubai, 35mm, Series #3560

ITEM	RRP	Ex GST
T9664	125.70	114.27
T9665	125.32	113.93
T9666	125.47	114.07
T9667	125.32	113.93
T9668	129.97	118.15
T9669	127.00	115.45
T9670	131.03	119.12
T9671	128.98	117.25
T9672	131.72	119.74
T9673	134.23	122.03
T9674	137.50	125.00
T9675	135.29	122.99
T9676	135.29	122.99
T9677	137.88	125.35
T9678	136.59	124.17
T9679	142.68	129.71
T9680	151.05	137.32
T9681	155.24	141.13

BEVEL EDGE CRANKED CHISELS - KIRSCHEN 2 CHERRIES - GERMAN MADE

Cranked chisels allow knuckle clearance when cleaning out right up to a corner. Ideal for removing glue squeeze out.



	ITEM	RRP	Ex GST
✓ Bench, 'S' Form Cranked, Flat Hornbeam Handle, 10mm	T8390	43.88	39.89
✓ Bench, 'S' Form Cranked, Flat Hornbeam Handle, 16mm	T8391	46.45	42.23
✓ Bench, 'S' Form Cranked, Flat Hornbeam Handle, 20mm	T8392	50.31	45.74

BENCH GOUGES - IN & OUT CANNEL - FLAT HORNBEAM HANDLE

Kirschen 2 Cherries. Bench gouges are available in either in-cannell, internally ground scribing gouges or out-cannell where the bevel is outside. German made.



OUT CANNEL	ITEM	RRP	Ex GST
✓ 6mm	T8666	46.15	41.95
✓ 8mm	T8667	46.95	42.68
✓ 10mm	T8668	47.25	42.95
✓ 12mm	T8669	47.95	43.59
✓ 14mm	T8670	48.25	43.86
✓ 16mm	T8671	48.95	44.50
✓ 18mm	T8672	50.90	46.27
✓ 20mm	T8673	50.90	46.27
✓ 22mm	T8674	57.33	52.12
✓ 24mm	T8675	58.35	53.05
✓ 26mm	T8676	59.95	54.50
✓ 28mm	T8677	67.86	61.69
✓ 30mm	T8678	69.15	62.86
✓ 32mm	T8679	80.73	73.39
✓ 35mm	T8680	88.92	80.84
✓ 40mm	T8681	99.45	90.41
✓ 45mm	T8682	119.34	108.49
✓ 50mm	T8683	147.42	134.02

IN CANNEL	ITEM	RRP	Ex GST
✓ 6mm	T8685	56.15	51.05
✓ 8mm	T8686	57.00	51.82
✓ 10mm	T8687	57.95	52.68
✓ 12mm	T8688	58.12	52.84
✓ 14mm	T8689	58.65	53.32
✓ 16mm	T8690	59.16	53.78
✓ 18mm	T8691	60.84	55.31
✓ 20mm	T8692	62.15	56.50
✓ 22mm	T8693	69.03	62.75
✓ 24mm	T8694	72.45	65.86
✓ 26mm	T8695	76.15	69.23
✓ 28mm	T8696	80.73	73.39
✓ 30mm	T8697	84.95	77.23

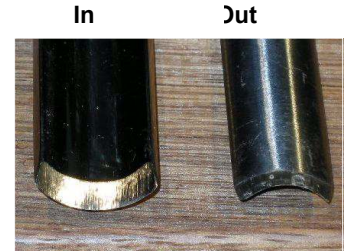

SORBY SPECIALISED CHISELS - BRITISH MADE

SORBY - PATTERNMAKERS BEVEL EDGE

Extra long reach blades and cushioned, boxwood paring handles. The last of their kind. Sheffield made.



	ITEM	RRP	Ex GST
✓ Chisel, Patternmakers Paring, 6mm, (1/4 inch), #241	T8962	93.48	84.98
✓ Chisel, Patternmakers Paring, 10mm, (3/8 inch), #241	T8964	96.25	87.50
✓ Chisel, Patternmakers Paring, 12mm, (1/2 inch), #241	T8965	99.07	90.07
✓ Chisel, Patternmakers Paring, 19mm, (3/4 inch), #241	T8967	104.73	95.21
✓ Chisel, Patternmakers Paring, 25mm, (1 inch), #241	T8968	110.44	100.40
✓ Chisel, Patternmakers Paring, 32mm, (1 1/4 inch), #241	T8969	119.34	108.49
✓ Chisel, Patternmakers Paring, 38mm, (1 1/2 inch), #241	T8970	129.26	117.51

#288 SORBY - HEAVY DUTY SASH MORTICE **34 SORBY - FIRMER - STEEL HOOP & CUSHION**
 Ash handled, cushioned and steel hooped. With rectangular section blade, cushion and steel hoop.



- ✓ Chisel, Ash Handle, 6mm, (1/4 inch), #288
- ✓ Chisel, Ash Handle, 10mm, (3/8 inch), #288
- ✓ Chisel, Ash Handle, 13mm, (1/2 inch), #288
- ✓ Chisel, Ash Handle, 16mm, (5/8 inch), #288
- ✓ Ash Handle, 6mm (1/4 inch) #284
- ✓ Ash Handle, 10mm (3/8 inch) #284
- ✓ Ash Handle, 13mm (1/2 inch) #284
- ✓ Ash Handle, 19mm (3/4 inch) #284
- ✓ Ash Handle, 25mm (1 inch) #284
- ✓ Ash Handle, 32mm (1 1/4 inch) #284
- ✓ Ash Handle, 38mm (1 1/2 inch) #284
- ✓ Ash Handle, 50mm (2 inch) #284

ITEM	RRP	Ex GST
T9030	111.97	101.79
T9031	112.90	102.64
T9032	113.92	103.57
T9033	117.22	106.56
T9036	70.73	64.30
T9037	72.71	66.10
T9038	73.73	67.03
T9039	77.56	70.51
T9040	88.11	80.10
T9041	100.17	91.06
T9042	114.65	104.23
T9043	135.65	123.32

#285 SORBY - FIRMER FRAMING - STEEL HOOPED

Massive, framing chisels intended for upsized work.

#286 SORBY - BEVELLED FRAMING - STEEL HOOPED

Bevelled framing chisels with cushion & ash handles.



- ✓ Ash Handle, 25mm (1 inch) #285
- ✓ Ash Handle, 38 mm (1 1/2 inch) #285
- ✓ Ash Handle, 50mm (2 inch) #285
- ✓ Heavy Duty, 25mm, (1 inch), Sorby, #286
- ✓ Heavy Duty, 38mm, (1 1/2 inch), Sorby, #286
- ✓ Heavy Duty, 50mm, (2 inch), Sorby, #286

ITEM	RRP	Ex GST
T9045	110.89	100.81
T9046	148.00	134.55
T9047	172.00	156.36
T9050	144.19	131.08
T9051	182.00	165.45
T9052	199.00	180.91

SORBY - CORNER

A smaller section option with boxwood paring handle and a monster for squaring the largest mortices.



T9078 - T9079

- ✓ Heavy Duty, 25mm (1 inch), #287
- ✓ Paring Handle, 10mm (3/8 inch), #333

ITEM	RRP	Ex GST
T9075	246.00	223.64
T9076	127.37	115.79

SORBY - SLICKS

- ✓ A slick is used to pare upscale tenons and other joint work
- ✓ Chisel, Slick, 2 3/8 inches (60mm), Sorby, #289
- ✓ Chisel, Slick, 3 3/8 inches (85mm), Sorby, #289
- ✓ Guard, for Sorby 2 3/8 inch (60mm) Slick, #F289EG60
- ✓ Guard, for Sorby 3 3/8 inch (85mm) Slick, #F2894E85

ITEM	RRP	Ex GST
T9078	217.60	197.81
T9079	232.94	211.76
A4160	17.55	15.95
A4161	19.89	18.08



STUBAI AUSTRIAN MADE WOOD DRILLING BITS

BRAD POINT OR DOWELING DRILLS - TOOL STEEL - STUBAI AUSTRIAN MADE

Offer sharply cut smooth holes in wood



	ITEM	RRP	Ex GST
✓ Drill, Brad Point, Stubai, 3mm, #300600	T3530	4.16	3.78
✓ Drill, Brad Point, Stubai, 4mm, #300601	T3531	4.68	4.25
✓ Drill, Brad Point, Stubai, 5mm, #300602	T3532	4.94	4.49
✓ Drill, Brad Point, Stubai, 6mm, #300603	T3533	5.45	4.96
✓ Drill, Brad Point, Stubai, 7mm, #300604	T3534	6.50	5.91
✓ Drill, Brad Point, Stubai, 8mm, #300605	T3535	7.79	7.09
✓ Drill, Brad Point, Stubai, 9mm, #300606	T3536	8.73	7.94
✓ Drill, Brad Point, Stubai, 10mm, #300607	T3537	9.46	8.60
✓ Drill, Brad Point, Stubai, Stepped Shank, 11mm, #300802	T3538	14.15	12.86
✓ Drill, Brad Point, Stubai, Stepped Shank, 12mm, #300803	T3539	15.58	14.16
✓ Drill, Brad Point, Stubai, Stepped Shank, 13mm, #300804	T3540	19.90	18.09
✓ Drill, Brad Point, Stubai, Stepped Shank, 14mm, #300805	T3541	21.37	19.43
✓ Drill, Brad Point, Stubai, Stepped Shank, 15mm, #300806	T3542	23.02	20.93
✓ Drill, Brad Point, Stubai, Stepped Shank, 16mm, #300807	T3543	24.36	22.14
✓ Drill, Brad Point, Stubai, Stepped Shank, 18mm, #300809	T3544	29.98	27.26
✓ Drill, Brad Point, Stubai, Stepped Shank, 20mm, #300810	T3545	33.75	30.68
✓ Drill, Brad Point, Stubai, Stepped Shank, 22mm, #300822	T3546	37.56	34.14
✓ Drill, Brad Point, Stubai, Stepped Shank, 24mm, #300824	T3547	43.22	39.29
✓ Drill, Brad Point, Stubai, Stepped Shank, 26mm, #300826	T3548	54.13	49.21
✓ Drill, Brad Point, Stubai, Stepped Shank, 28mm, #300828	T3549	59.49	54.08

UNIVERSAL BORERS - IN TOOL STEEL AND TCT - STUBAI AUSTRIAN MADE

Universal borers are a much improved version of a forstner bit and offer wide chip gates and ultra smooth edge cutting



	ITEM	RRP	Ex GST
✓ Borer, Universal, TCT, 14mm, #308606	T0285	50.19	45.62
✓ Borer, Universal, TCT, 15mm, #308607	T0286	48.30	43.91
✓ Borer, Universal, TCT, 16mm, #308608	T0287	43.28	39.35
✓ Borer, Universal, TCT, 17mm, #308625	T0288	51.50	46.82
✓ Borer, Universal, TCT, 18mm, #308609	T0289	45.25	41.14
✓ Borer, Universal, TCT, 20mm, #308610	T0290	51.13	46.48
✓ Borer, Universal, TCT, 22mm, #308611	T0291	50.93	46.30
✓ Borer, Universal, TCT, 23mm, #308628	T0292	53.43	48.58
✓ Borer, Universal, TCT, 24mm, #308612	T0293	43.49	39.53
✓ Borer, Universal, TCT, 25mm, #308613	T0294	53.60	48.73
✓ Borer, Universal, TCT, 26mm, #308614	T0295	55.28	50.26
✓ Borer, Universal, TCT, 28mm, #308615	T0296	57.09	51.90
✓ Borer, Universal, TCT, 30mm, #308616	T0297	57.46	52.24
✓ Borer, Universal, TCT, 32mm, #308617	T0298	53.56	48.69
✓ Borer, Universal, TCT, 35mm, #308619	T0299	62.35	56.69
✓ Borer, Universal, TCT, 36mm, #308622	T0300	75.26	68.42
✓ Borer, Universal, TCT, 40mm, #308620	T0301	76.08	69.17

VARIABLE DIAMETER EXPANSION DRILLS

Best used in a drill press. These are excellent and the pattern the cheapies copied.



	ITEM	RRP	Ex GST
✓ Drill, Expansion, 13mm to 35mm, #298001	T0306	71.78	65.26
✓ Drill, Expansion, 22mm to 70mm, #299001	T0307	129.60	117.82

UNIVERSAL BORERS - SETS

- ✓ Borer, Set of 4, 20.25.30.35mm, #308554
- ✓ Borer, Set of 5, 15.20.25.30.35mm, #308555
- ✓ Borer, TCT, Set of 5, 15.20.25.30.35mm, #308655

ITEM	RRP	Ex GST
T0310	77.18	70.17
T0311	102.85	93.50
T0312	142.45	129.50

UNIVERSAL BORERS TOOL STEEL

- ✓ Borer, Universal, 8mm, #308501
- ✓ Borer, Universal, 10mm, #308502
- ✓ Borer, Universal, 11mm, #308503
- ✓ Borer, Universal, 12mm, #308504
- ✓ Borer, Universal, 13mm, #308505
- ✓ Borer, Universal, 14mm, #308506
- ✓ Borer, Universal, 15mm, #308507
- ✓ Borer, Universal, 16mm, #308508
- ✓ Borer, Universal, 18mm, #308509
- ✓ Borer, Universal, 20mm, #308510
- ✓ Borer, Universal, 22mm, #308511
- ✓ Borer, Universal, 24mm, #308512
- ✓ Borer, Universal, 25mm, #308513
- ✓ Borer, Universal, 26mm, #308514
- ✓ Borer, Universal, 28mm, #308515
- ✓ Borer, Universal, 30mm, #308516
- ✓ Borer, Universal, 32mm, #308517
- ✓ Borer, Universal, 34mm, #308518
- ✓ Borer, Universal, 35mm, #308519
- ✓ Borer, Universal, 36mm, #308520
- ✓ Borer, Universal, 38mm, #308521
- ✓ Borer, Universal, 40mm, #308522
- ✓ Borer, Universal, 45mm, #308523
- ✓ Borer, Universal, 50mm, #308524

T0320	16.53	15.03
T0321	17.61	16.01
T0322	19.90	18.09
T0323	19.56	17.78
T0324	20.68	18.80
T0325	21.81	19.82
T0326	21.94	19.94
T0327	22.80	20.73
T0328	23.45	21.32
T0329	24.66	22.42
T0330	25.61	23.29
T0331	27.73	25.21
T0332	27.86	25.33
T0334	29.12	26.47
T0335	30.98	28.16
T0336	32.36	29.42
T0337	36.04	32.76
T0338	39.42	35.83
T0339	40.28	36.62
T0340	41.58	37.80
T0341	44.26	40.24
T0342	46.47	42.24
T0343	56.77	51.61
T0344	67.06	60.97

DOWELING JIGS - JOINT GENIE - BRITISH MADE

Doweling jigs might be seen as a bit old school but not Joint Genie which, as well as being the world's most flexible doweling system, is equally useful for locating shelf support pins and other hardware in both sheet and post & rail work.

JOINT GENIE DOWELING JIGS - BRITISH MADE

Doweling remains one of the simplest and strongest methods of joining wood and one of the safest for schools.

Given a quality adhesive and hardwood dowels, Joint Genie jigs allow the simple joining of sheet and post & rail structures for a wide variety of woodworking.

See our site for a link to a demonstration DVD. Contact us for dowel purchase options

Craftsman 8mm



Multi Professional 6/8/10mm



- ✓ 'Joint Genie', Craftsmen, 8mm
- ✓ 'Joint Genie', Professional, 6mm
- ✓ 'Joint Genie', Professional, 8mm
- ✓ 'Joint Genie', Professional, 10mm
- ✓ 'Joint Genie', Multi Professional, 6mm, 8mm, 10mm
- ✓ 'Joint Genie', Jobber, 6mm
- ✓ 'Joint Genie', Jobber, 8mm

ITEM	RRP	Ex GST
E0136	265.91	241.74
E0143	152.19	138.35
E0144	158.62	144.20
E0145	158.62	144.20
E0151	300.19	272.90
E0155	116.30	105.73
E0156	116.30	105.73

JAPANESE SAWS

Japanese saws offer exceptional accuracy, rapid cutting and replaceable blades.
We offer over 50 options - see our site for a full listing

180mm EVA HANDLE SERIES

This range has become the standard in teaching institutions across Europe with long lasting, hardened tooth & replaceable blades.

T1385 USUBA

Usuba, Overall 390mm, Blade 0.3 x 180mm,
Depth of Cut 45mm, Pitch 1.5mm (16.93tpi),
Piercing Nose, Stiffened, EVA Handle, #290



T1385 ATSUBA

Atsuba, Overall 390mm, Blade 0.5 x 180mm,
Depth of Cut Unlimited, Pitch 1.5mm (16.93tpi),
Piercing Nose, Non Stiffened, EVA Handle, #293

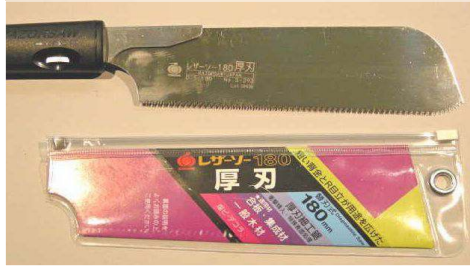

T1387 JUSHI

Jushi, Overall 390mm, Blade 0.3 x 180mm,
Depth of Cut 45mm, Pitch 1.5mm (16.93tpi),
Stiffened, EVA Handle, #295



T1404 RYOBA

Ryoba, 180, Rip/Crosscut, Overall 390mm,
Blade 0.5mm x 180mm, Crosscut Pitch 1.5mm, Rip Pitch 2.7~3.5mm,
EVA Handle, #291



T1389 DOZUKI NOKO

Dozuki Noko, Universal Tooth, Overall 390mm,
Blade 0.3 x 180mm, Depth of Cut 45mm,
Pitch 1.0mm (25.4tpi), EVA Handle, #297



- ✓ Usuba #290
- ✓ Atsuba #293
- ✓ Jushi #295
- ✓ Dozuki Noko #297
- ✓ Dozuki Noko, Box of 12, #297
- ✓ Ryoba #291

ITEM	RRP	Ex GST
T1385	44.33	40.30
T1386	44.33	40.30
T1387	44.33	40.30
T1388	56.00	50.91
T1389	550.00	500.00
T1404	46.67	42.42

240-270mm CANE WRAPPED HANDLE SERIES

This traditional range contains the best selling Japanese saws worldwide. They have long lasting, hardened tooth & replaceable blades.

T1400 SUNCHILD DOZUKI

Dozuki, Sunchild, Universal Tooth,
Overall 530mm, Blade 0.3 x 240mm, Depth of Cut 45mm,
Tooth Pitch 1.3mm (19.54TPI), Cane Handle, #311H



T1401 ZA DOZUKI

Dozuki, Piercing Nose, Cross Cut Teeth,
Overall 530mm, Blade 0.3 x 240mm, Depth of Cut 45mm,
Tooth pitch 1.5mm (16.93TPI), Cane Handle, #306ZA



T1397 & T1398 DOZUKI NOKO

Dozuki, Noko, Crosscut Tooth, Overall 530mm, Blade 0.3 x 240mm, Tooth Pitch 1.0mm (25.4TPI), Depth of Cut T1397 50mm OR T1398 60mm.



T1403 KATABA

Saw, Japanese, Kataba, Backless, Crosscut Teeth, Overall 555mm, Blade 0.5 x 255mm, Tooth pitch 1.3mm (19.54 TPI), Cane Handle, #105



T1405 RYOBA NOKO

Ryoba, Blue Hard, Rip/Crosscut, Overall 580mm, Blade 0.45mm x 240mm, Crosscut Pitch 1.3mm Rip Pitch 2.5~3.5mm, Cane Handle, #651



T1405 SET OF 4 CANE HANDLED

Saw, Japanese, Set of 4, Sunchild Dozuki, ZA Dozuki, 105 Kataba, 651 Ryob
Blade 0.45mm x 240mm, Crosscut Pitch 1.3mm
Rip Pitch 2.5~3.5mm, Cane Handle, #651



T1436 ORIKOMI - FOLDING

Orikomi, All Purpose, Overall Unfolded 520mm, Folded 285mm, Blade 0.8 x 250mm, Crosscut & Rip Teeth, 2.5mm Pitch (10.16TPI)



- ✓ Sunchild Dozuki
- ✓ ZA Dozuki
- ✓ Dozuki Noko, 50mm MAX CUT
- ✓ Dozuki Noko, 60mm MAX CUT
- ✓ Kataba
- ✓ Ryoba
- ✓ Set of 4, Sunchild Dozuki, ZA Dozuki, Kataba, Ryoba
- ✓ Orikomi

ITEM	RRP	Ex GST
T1400	58.33	53.03
T1401	68.13	61.94
T1397	84.95	77.23
T1398	90.75	82.50
T1403	63.59	57.81
T1405	69.95	63.59
T1380	195.00	177.27
T1436	56.00	50.91

MARPLES & STUBAI LAYOUT TOOLS

Marples

- ✓ Awl, Beech, Round Blade, Screwdriver Point, 50mm blade
- ✓ Awl, Beech, Reaming, Ground Square Blade, 50mm blade

Stubai

- ✓ Awl, Joiners, 7 x 115mm round blade, #346001
- ✓ Awl, Joiners, 7 x 115mm ground square blade, #347001
- ✓ Awl, Brad, 3 x 40mm round blade, #348001
- ✓ Awl, Brad, 5 x 60mm round blade, #348002
- ✓ Awl, Brad, 5.5 x 80mm round blade, #348003
- ✓ Awl, Reaming, 5.5 x 60mm reaming blade, #349001
- ✓ Awl, Reaming, 6.0 x 80mm reaming blade, #349002

- ✓ Knife, Marking, Right Hand, Beech, #125
- ✓ Knife, Marking, Right Hand, Rosewood, #25

MARKING GAUGES

- ✓ Beech, Half Round, Wood Face, Plastic Screw, #1
- ✓ Beech, Half Round, Brass Face, Plastic Screw, #2
- ✓ Rosewood, Half Round, Brass Face, Brass Screw, #6

T7026	8.95	8.14
T7027	14.95	13.59
T6990	15.39	13.99
T6991	17.01	15.47
T6993	6.74	6.12
T6994	8.70	7.91
T6995	9.15	8.31
T6997	9.44	8.58
T6998	9.74	8.85
T7324	8.95	8.14
T7325	9.95	9.05
T7448	10.21	9.28
T7449	15.00	13.64
T7455	18.75	17.05

T7026



T7027



Stubai Pattern Awls



T7324 - T7325



MORTICE & MARKING COMBINATION GAUGES - SQUARE HEAD

✓ Beech, Slide Action, Wood Face, Plastic Screw, #7	T7457	18.54	16.86
✓ Beech, Slide Action, Brass Face, Plastic Screw, #8	T7458	25.21	22.92
✓ Rosewood, Slide Action, Brass Face, Brass Screw, #10C	T7460	50.00	45.45
✓ Rosewood, Screw Action, Brass Face, Brass Screw, #13C	T7461	83.25	75.68

CUTTING GAUGES - HALF ROUND HEAD

✓ Beech, Brass Face, Plastic Thumb Screw, #4	T7465	20.21	18.37
✓ Rosewood, Brass Face, Brass Thumb Screw, #6a	T7469	39.25	35.68

PANEL GAUGES - ROSEWOOD, BRASS FACE, BRASS SCREW

✓ Gauge, Panel, Square Head, gauges to 600mm, #15	T7471	36.50	33.18
---	-------	-------	-------

MARPLES SQUARES - TRY, BEECH

✓ Try, Beech Stock, 150mm, #200	T7435	18.38	16.70
✓ Try, Beech Stock, 225mm, #201	T7436	21.88	19.89
✓ Try, Beech Stock, 300mm, #202	T7437	24.21	22.01

MARPLES SQUARES - TRY, ROSEWOOD

✓ Square, Try, 150mm, #19A	T7439	38.00	34.55
✓ Square, Try, 225mm, #19B	T7440	45.75	41.59
✓ Square, Try, 300mm, #19C	T7441	57.50	52.27

MARPLES MITRE SQUARES - ROSEWOOD

✓ 250mm, #19M	T7443	50.25	45.68
✓ 380mm, #19P	T7444	57.00	51.82

MARPLES TRY & MITRE SQUARES - ROSEWOOD

✓ 250mm, #19T	T7446	45.25	41.14
---------------	-------	-------	-------

MARPLES SLIDING BEVELS, WINGNUT LOCK

✓ Bevel, Sliding, Wing Nut Lock, Beech, 190mm, #210	T7473	11.67	10.61
✓ Bevel, Sliding, Wing Nut Lock, Beech, 225mm, #211	T7474	12.17	11.06

MARPLES SLIDING BEVELS, THUMBWHEEL LOCK

✓ Bevel, Sliding, Rosewood, 190mm, #20D	T7479	28.75	26.14
✓ Bevel, Sliding, Rosewood, 225mm, #20E	T7480	33.25	30.23
✓ Bevel, Sliding, Rosewood, 300mm, #20H	T7482	46.25	42.05

MARPLES AWLS - BEECH

✓ Round Blade, Screwdriver Point, 50mm blade, #22E	T7026	8.95	8.14
✓ Reaming, Ground Square Blade, 50mm blade, #26	T7027	14.95	13.59

MARPLES CARPENTER'S MALLET - BEECH

✓ Mallet, Carpenter's, Beech, 114mm, #30a	T3381	24.95	22.68
---	-------	-------	-------

MARPLES MARKING KNIVES

✓ Knife, Marking, Right Hand, Beech, #125	T7324	8.95	8.14
✓ Knife, Marking, Right Hand, Rosewood, #25	T7325	9.95	9.05

HERITAGE 'TRIAL' RANGE - ROSEWOOD

The Marples Trial range are top of the line tools with generous design details and brass plating. The presentation box is very popular for graduating apprentices or students or retiring teachers.

MARPLES PRESENTATION BOX SET

✓ Tools, Set, Layout and Marking, Marples Trail 1, In Presentation Box, #Tbox	T7427	324.73	295.21
	ITEM	RRP	Ex GST
✓ Square, Try, Trial 1 range, 150mm, #T06	T7421	50.25	45.68
✓ Square, Try, Trial 1 range, 225mm, #T09	T7422	57.50	52.27
✓ Square, Try, Trial 1 range, 300mm, #T12	T7423	72.00	65.45
✓ Square, Mitre, Trial 1 range, 250mm, #T15	T7424	81.00	73.64
✓ Gauge, Trial 1 range, Shield Head, #T14	T7425	112.75	102.50
✓ Bevel, Sliding, #T20	T7426	61.75	56.14
✓ Boxed Set, Marples Trail 1, #Tbox	T7427	324.73	295.21

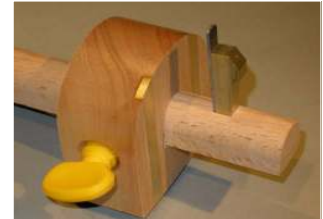
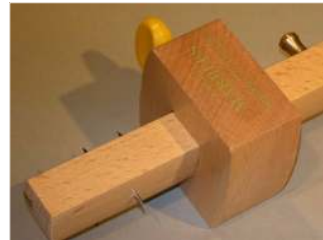

SCROLL SAWING

The Multicut 1 is our best selling quality scroll saw with an excellent service record & with thousands in use in Australian schools. A quality scroll saw is undoubtedly the safest powered wood saw available for use in schools. Statistically the very small risk profile of scroll saws suggests eye injury from broken blade parts & being hurt by machines falling off benches exceed the minimal risk of being cut by the blade. Hegner scroll saws can be bolted to the bench & the patented blade retaining system greatly minimises risk from blade fragments. Despite this we still suggest eye protection must be worn at all times. The Multicut 1 is available in either single or variable speed models. Blade guards & work hold down arms available. Variable speed is factory fitted & must be specified at order time. Note that Hegner scroll saws use pinless blades of which there are numerous patterns & sizes to enable working with the widest variety of materials. Other scroll saw use pinned blades which are more expensive, available in only 3 or 4 patterns & may be limited to wood. The patented Hegner blade clamp arrangement contains broken blades & minimises risks from pieces of blade being thrown about. These machines are fully supported with spare parts & maintenance across Australia. We routinely service machines more than 25 years old which are still in excellent functioning condition.

Hegner Multicut 1



Hegner Multicut 2S



- ✓ Saw, Scroll, Multicut 1, single speed
- ✓ Saw, Scroll, Multicut 1, vari speed
- ✓ Saw, Scroll, Multicut-2S, vari speed
- ✓ Saw, Scroll, Multicut-SE, vari speed

POPULAR SPARES, ACCESSORIES & UPGRADES

- ✓ Assembly, Jointhose, for M1
- ✓ Assembly, Jointhose, for M2S / SE / Quick
- ✓ Arm, Hold Down for Multicut 1 - WITHOUT GUARD
- ✓ Arm, Hold Down for Multicut 2S - WITHOUT GUARD
- ✓ Arm, Hold Down for Multicut 1 - WITH BLADE GUARD
- ✓ Arm, Hold Down for Multicut 2S - WITH BLADE GUARD
- ✓ Guard, Blade, for use with Multicut Hold Down Arm
- ✓ Part, Multicut 1, #023, Clamp, Blade
- ✓ Clamp, Quick Release, for Inside Sawing
- ✓ Key, Blade Fitting, for Hegner Blade Clamps
- ✓ Switch, Foot, for M1 / M2 / SE / Quick
- ✓ Lamp, Machine, for Multicut 1 (Screw cap lampholder)

ITEM	RRP	Ex GST
M0239	995.00	904.55
M0240	1,395.00	1,268.18
M0242	1,995.00	1,813.64
M0243	2,395.00	2,177.27

S6914	73.27	66.61
S6916	77.31	70.28
A7050	121.00	110.00
A7051	121.00	110.00
A7060	132.95	120.86
A7061	132.95	120.86
A7040	34.95	31.77
S1014	19.95	18.14
S6845	52.73	47.94
S0977	17.95	16.32
A7070	149.95	136.32
A7072	69.95	63.59

- improved dust collection
- improved dust collection
- holds work on table while cutting
- holds work on table while cutting
- supports guard & holds work on table
- supports guard & holds work on table
- screws onto hold down arm
- spare standard blade clamp
- assists with pierced work
- spare tightening key
- allows hands free stop start
- improves work station lighting

S6914 & S6916 Jointhose

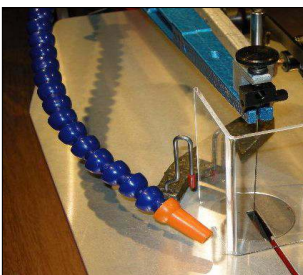

A7040 Blade guard

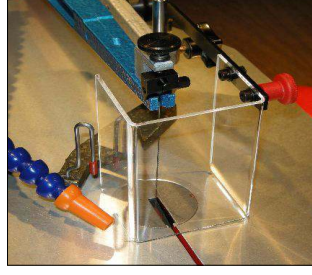

S1014

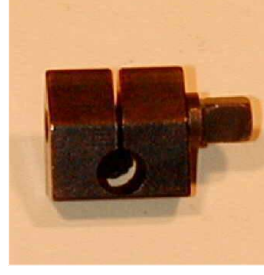

S6845



S0977



A7070



A7072



A7074 & S1001A



MULTICUT SPECIFICATIONS

Models 1 and 1e

Shipping Weight	20 kg
Machine weight	16 kg
Warranty	3 years
Length	520mm (20 inches)
Width	270mm (11 inches)
Throat	365mm (14 inches)
Max Cut	50mm (2 inches)
Blades	Pinless 130 mm (5 inch)
Table	Machined alloy
Table size	435mm x 230mm (17" x 9")
Table tilt	0~45 degrees
Quick Tension Release	Yes at Rear
Quick Blade Clamp	No (accessory)
Indicative Noise At Idle	64.1 dB(A)
Indicative Noise Machining	74.5 dB(A)
Dust management	Dual - bellows blower & vacuum port
Stroke	Two options - 12 & 18mm
Ex Factory Stroke Setting	18mm
Speed Fixed (Model 1)	1400 spm
Speed Variable (Model 1e)	400~1400 spm
Motor	100Watts (230v, 50Hz, AC)
Motor Type (Model 1)	TEFC Cap start continuous duty
Motor Type (Model 1e)	TEFC VS drive continuous duty
Motor rating	Continuous
Indicative Capacities	
Soft Wood	50mm
Hard Wood	40mm
Alloy, Copper, Brass	5mm
Hard plastics, perspex	15mm
Polyurethane foam	50mm

Models 2S and 2Se

Shipping Weight	22 kg
Machine Weight	19kg
Warranty	3 years
Length	610mm (24 inches)
Width	280mm (11 inches)
Throat	460mm (18 inches)
Max Cut	65mm (2 1/2 inches)
Blades	Pinless 130 mm (5 inch)
Table 2S & 2Se	Machined alloy
Table size	435mm x 230mm (17" x 9")
Table tilt	-12 ~ +45 degrees
Quick Arm Tension Release	Yes at Front
Quick Blade Clamp	Yes
Indicative Noise At Idle	64.1 dB(A)
Indicative Noise Machining	74.5 dB(A)
Dust management	Dual - bellows blower & vacuum
Stroke	Two options - 12 & 19mm
Ex Factory Stroke Setting	19mm
Speed Fixed (Model 2S)	1400 spm
Speed variable (Model 2Se)	400~1400 spm
Motor	100Watts (230v, 50Hz, AC)
Motor Type (Model 2S)	TEFC Cap start contin. duty
Motor Type (Model 2Se)	TEFC VS drive contin. duty
Motor rating	Continuous
Indicative Capacities	
Soft Wood	65mm
Hard Wood	50mm
Alloy, Copper	5mm
Brass, Silver	10mm
Iron soft steel	8mm

BLADES - FOR SCROLL AND COPING SAWS

GENERAL PURPOSE (Note: 1 gross = 12 dozen)

General purpose blade for wood, plastics etc.

- ✓ Pebeco Pinless, 1doz, #3, PEBECO, #180
- ✓ Pebeco Pinless, 1doz, #5, PEBECO, #180
- ✓ Pebeco Pinless, 1doz, #7, PEBECO, #180
- ✓ Pebeco Pinless, 1doz, #9, PEBECO, #180
- ✓ Pebeco Pinless, 1doz, #14, PEBECO, #180
- ✓ Pebeco Pinless, 1gross, #3, PEBECO, #180
- ✓ Pebeco Pinless, 1gross, #5, PEBECO, #180
- ✓ Pebeco Pinless, 1gross, #7, PEBECO, #180
- ✓ Pebeco Pinless, 1gross, #9, PEBECO, #180
- ✓ Pebeco Pinless, 1gross, #14, PEBECO, #180

ITEM	RRP	Ex GST
L1404	11.90	10.82
L1406	11.90	10.82
L1408	11.62	10.56
L1410	12.64	11.50
L1413	13.25	12.05
L1433	95.35	86.68
L1435	95.35	86.68
L1437	98.40	89.45
L1439	98.40	89.45
L1442	109.15	99.23

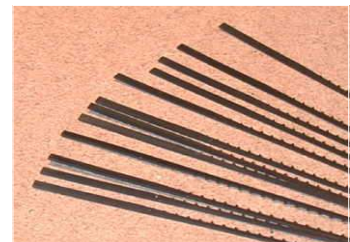

ULTRA SMOOTH CUT - HAVE SOME UNDERSIDE UPWARD FACING TEETH (Note: 1 gross = 12 dozen)

Fix/reverse blades have some upward cutting teeth to minimise tearout on the bottom of the work

- ✓ Fix/Reverse Pinless, 1 doz, #1
- ✓ Fix/Reverse Pinless, 1doz, #5,
- ✓ Fix/Reverse Pinless, 1doz, #7,
- ✓ Fix/Reverse Pinless, 1doz, #9,
- ✓ Fix/Reverse Pinless, 1doz, #12,
- ✓ Fix/Reverse Pinless, 1gross, #1,
- ✓ Fix/Reverse Pinless, 1gross, #5,
- ✓ Fix/Reverse Pinless, 1gross, #7,
- ✓ Fix/Reverse Pinless, 1gross, #9,
- ✓ Fix/Reverse Pinless, 1gross, #12,

L1371	11.90	10.82
L1373	11.62	10.56
L1374	12.64	11.50
L1375	13.25	12.05
L1376	13.25	12.05
L1391	88.15	80.14
L1393	96.15	87.41
L1394	97.12	88.29
L1395	106.37	96.70
L1396	116.12	105.56



TWISTER BLADES - CUT IN ALL DIRECTIONS (Note: 1 gross = 12 dozen)

Twister blades have spirally teeth which allows cuts in any direction without rotating the work

- ✓ Blades, Scroll Saw, Pinless, 1doz, #1, TWISTER
- ✓ Blades, Scroll Saw, Pinless, 1doz, #3, TWISTER
- ✓ Blades, Scroll Saw, Pinless, 1doz, #5, TWISTER
- ✓ Blades, Scroll Saw, Pinless, 1 Gross, #1, TWISTER
- ✓ Blades, Scroll Saw, Pinless, 1 Gross, #3, TWISTER
- ✓ Blades, Scroll Saw, Pinless, 1 Gross, #5, TWISTER

L1445	14.52	13.20
L1446	14.52	13.20
L1447	14.52	13.20
L1450	109.94	99.95
L1451	111.13	101.03
L1452	113.66	103.33

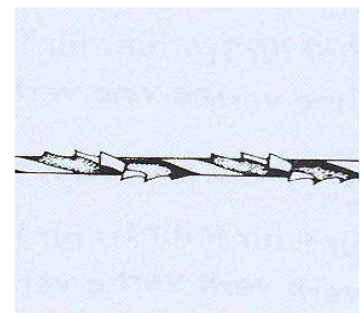

METAL CUTTING - FOR SOFT METALS (Note: 1 gross = 12 dozen)

✓ Blades, Scroll Saw, Pinless, 1 doz, #1 ANTILOPE BLUE	L1535	15.83	14.39
✓ Blades, Scroll Saw, Pinless, 1 doz, #3 ANTILOPE BLUE	L1536	15.74	14.31
✓ Blades, Scroll Saw, Pinless, 1 doz, #5 ANTILOPE BLUE	L1537	17.32	15.75
✓ Blades, Scroll Saw, Pinless, 1 doz, #7 ANTILOPE BLUE	L1538	21.62	19.65
✓ Blades, Scroll Saw, Pinless, 1 doz, #9 ANTILOPE BLUE	L1539	25.92	23.56
✓ Blades, Scroll Saw, Pinless, 1 gross, #1 ANTILOPE BLUE	L1550	146.12	132.84
✓ Blades, Scroll Saw, Pinless, 1 gross, #3 ANTILOPE BLUE	L1551	145.26	132.05
✓ Blades, Scroll Saw, Pinless, 1 gross, #5 ANTILOPE BLUE	L1552	159.91	145.38
✓ Blades, Scroll Saw, Pinless, 1 gross, #7 ANTILOPE BLUE	L1553	199.57	181.43
✓ Blades, Scroll Saw, Pinless, 1 gross, #9 ANTILOPE BLUE	L1554	239.22	217.48

PINNED BLADES FOR OTHER MACHINES (Note: 1 gross = 12 dozen)

✓ Blades, Scroll Saw, Pinned, 130mm 10 tpi, pkt of dozen,	L1660	14.78	13.44
✓ Blades, Scroll Saw, Pinned, 130mm 15 tpi, pkt of dozen,	L1661	14.78	13.44
✓ Blades, Scroll Saw, Pinned, 130mm 20 tpi, pkt of dozen	L1662	14.78	13.44
✓ Blades, Scroll Saw, Pinned, 130mm 25 tpi, pkt of dozen	L1663	14.78	13.44
✓ Blades, Scroll Saw, Pinned, 130mm 10 tpi, 1 Gross	L1670	177.41	161.29
✓ Blades, Scroll Saw, Pinned, 130mm 15 tpi, 1 Gross	L1671	177.41	161.29
✓ Blades, Scroll Saw, Pinned, 130mm 20 tpi, 1 Gross	L1672	177.41	161.29
✓ Blades, Scroll Saw, Pinned, 130mm 25 tpi, 1 Gross	L1673	177.41	161.29

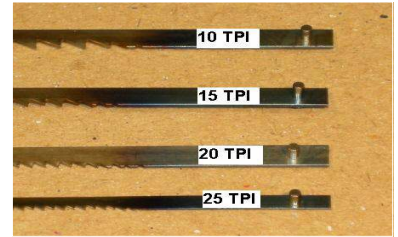

BLADE DIMENSIONS

ITEM	COUNT	SIZE	Pins	LONG	REV. TEETH	KERF	WIDTH	TPI	PITCH mm
PEBECO 180									
L1400	1 x doz	#2/0	no	130mm		0.25	0.58	30	0.85
L1404	1 x doz	#3	no	130mm		0.34	0.77	20	1.27
L1406	1 x doz	#5	no	130mm		0.39	1.03	17	1.54
L1408	1 x doz	#7	no	130mm		0.44	1.20	14	1.81
L1410	1 x doz	#9	no	130mm		0.48	1.50	14	1.81
L1413	1 x doz	#14	no	130mm		0.55	1.90	10	2.54
L1429	12 x doz	#2/0	no	130mm		0.25	0.58	30	0.85
L1433	12 x doz	#3	no	130mm		0.34	0.77	20	1.27
L1435	12 x doz	#5	no	130mm		0.39	1.03	17	1.54
L1437	12 x doz	#7	no	130mm		0.44	1.20	14	1.81
L1439	12 x doz	#9	no	130mm		0.48	1.50	14	1.81
L1442	12 x doz	#14	no	130mm		0.55	1.90	10	2.54
FIX / REVERSE 400/R									
L1371	1 x doz	#1	no	130mm	8	0.30	0.77	15	1.69
L1373	1 x doz	#5	no	130mm	8	0.38	0.93	12	2.12
L1374	1 x doz	#7	no	130mm	8	0.42	1.10	12	2.12
L1375	1 x doz	#9	no	130mm	8	0.46	1.35	12	2.12
L1376	1 x doz	#12	no	130mm	4	0.52	1.70	8	3.18
L1391	12 x doz	#1	no	130mm	8	0.30	0.77	15	1.69
L1393	12 x doz	#5	no	130mm	8	0.38	0.93	12	2.12
L1394	12 x doz	#7	no	130mm	8	0.42	1.10	12	2.12
L1395	12 x doz	#9	no	130mm	8	0.46	1.35	12	2.12
L1396	12 x doz	#12	no	130mm	4	0.52	1.70	8	3.18
TWISTER									
L1445	1 x doz	#1	no	130mm	7	0.72	0.70		
L1446	1 x doz	#3	no	130mm	7	0.85	0.77		
L1447	1 x doz	#5	no	130mm	7	0.88	0.90		
L1450	12 x doz	#1	no	130mm	7	0.72	0.70		
L1451	12 x doz	#3	no	130mm	7	0.85	0.77		
L1452	12 x doz	#5	no	130mm	7	0.88	0.90		
METAL CUTTING									
L1535	1 x doz	#1	no	130mm		0.28	0.62	51	0.50
L1536	1 x doz	#3	no	130mm		0.36	0.75	41	0.63
L1537	1 x doz	#5	no	130mm		0.40	0.85	33	0.77
L1538	1 x doz	#7	no	130mm		0.50	1.10	28	0.91
L1539	1 x doz	#9	no	130mm		0.55	1.30	23	1.11
L1550	12 x doz	#1	no	130mm		0.28	0.62	51	0.50
L1551	12 x doz	#3	no	130mm		0.36	0.75	41	0.63
L1552	12 x doz	#5	no	130mm		0.40	0.85	33	0.77
L1553	12 x doz	#7	no	130mm		0.50	1.10	28	0.91
L1554	12 x doz	#9	no	130mm		0.55	1.30	23	1.11

PINNED SCROLLSAW BLADES

L1660	1 x doz	10	yes	130mm	0.50	3.00	10	2.54
L1661	1 x doz	15	yes	130mm	0.50	3.00	15	1.69
L1662	1 x doz	20	yes	130mm	0.50	3.00	20	1.27
L1663	1 x doz	25	yes	130mm	0.25	2.00	25	1.02
L1670	12 x doz	10	yes	130mm	0.50	3.00	10	2.54
L1671	12 x doz	15	yes	130mm	0.50	3.00	15	1.69
L1672	12 x doz	20	yes	130mm	0.50	3.00	20	1.27
L1673	12 x doz	25	yes	130mm	0.25	2.00	25	1.02

PINNED COPING SAW

L1891	1 x doz		yes	165mm	0.50		15	1.69
L1892	12 x doz		yes	165mm	0.50		15	1.69
L1893	1 x doz		yes	165mm	0.50		20	1.27
L1894	12 x doz		yes	165mm	0.50		20	1.27

DECORATIVE JOINTING

The ZFG is a simple, safe machine with excellent dust/chip extraction which offers students the capability of making perfect finger joints. We have a number of school customers making serving trays, lidded boxes and pencil boxes made with the ZFG for middle and senior secondary years. The ZFG has a fully guarded cutter and has proven a safer option than the use of hand held routers on dovetail jigs. Now with improved, more powerful router motor.



Helicly ground cutters for ZFG



FINGER JOINTER - HEGNER - GERMANY

- ✓ Finger Jointer, ZFG Comb/Finger Jointing Machine

ITEM	RRP	Ex GST
M0478	1,195.00	1,086.36

CUTTERS

The machine is supplied with either 8mm or 6.35 (1/4 inch) shank helicly ground special router cutters in 4mm, 6mm, 8mm and 10mm diameters. The 8mm shank cutters are preferred as they are more robust. There is also a 12mm diameter cutter available

- ✓ Bit, Router, 4mm, 6.35mm Shank, ZFG Comb Jointer
- ✓ Bit, Router, 6mm, 6.35mm Shank, ZFG Comb Jointer
- ✓ Bit, Router, 8mm, 6.35mm Shank, ZFG Comb Jointer
- ✓ Bit, Router, 10mm, 6.35mm Shank, ZFG Comb Jointer
- ✓ Bit, Router, 12mm, 6.35mm Shank, ZFG Comb Jointer
- ✓ Bit, Router, 4mm, 8mm Shank, ZFG Comb Jointer
- ✓ Bit, Router, 6mm, 8mm Shank, ZFG Comb Jointer
- ✓ Bit, Router, 8mm, 8mm Shank, ZFG Comb Jointer
- ✓ Bit, Router, 10mm, 8mm Shank, ZFG Comb Jointer
- ✓ Bit, Router, 12mm, 8mm Shank, ZFG Comb Jointer

ITEM	RRP	Ex GST
R6202	47.67	43.33
R6203	47.67	43.33
R6204	47.67	43.33
R6205	47.67	43.33
R6206	47.67	43.33
R6210	47.67	43.33
R6211	47.67	43.33
R6212	47.67	43.33
R6213	47.67	43.33
R6214	47.67	43.33



VACUUMS

HEGNER MAXIMUS UNDERBENCH VACUUM

The Hegner Maximus is the perfect machine for installations where distributed dust control is installed.

The Maximus from Hegner is a down-size, quiet vacuum with variable suction which is ideally suited to placement under work benches.

It has a master-slave feature which allows bench top machines to automatically switch the vacuum on and off.

This saves on power consumption and reduces noise in the work room. Only 62dB (A) at max power

- ✓ Vacuum/Dust Extractor, Maximus 13E
- ✓ Bag, Filter, for Hegner Maximus 13E, 10 pieces

ITEM	RRP	Ex GST
M0920	589.55	535.95
C0720	72.19	65.63

Specifications

Model	Hegner Maximus 13E
Height	405mm
Width	290mm
Depth	400mm
Weight	tba
Mains	230 volt AC, 50 Hz
Max power	1250 watts
Noise at Max power	62dB(A)
Variable suction & noise	Yes
Dust volume	13 litres
Mains cable	10 metres
Dust hose	2.5 metres
Hose swivel connection	Yes
Suction throughput	Max. 60 litres/sec
Vacuum Pressure	290 mbar
Filtration	HEPA H21
Bags	Yes, disposable (See C0720)
Accessories	Floor wand, Crevice & Furniture Brush Upholstery nozzles



SANDING

HEGNER SANDERS

The WSM German made Hegner disc sander has a 300mm, fully guarded velcro equipped hook disc & is equipped with no-volt starting. It is fitted with an efficient dust collection port.

The HSM-300S has a tilting disc and fixed table which allows heavier pieces to be work. Digital tilt gauge is an option.

The TWS 230 table drum sander has a sanding width of 230mm and table 520mm x 320mm. Fence is optional. The TWS is the perfect companion machine for the Hegner scroll saws and finger jointers. With a fence fitted (please order as accessory) and table height perfectly adjusted it can final sand most scroll saw and box projects very safely.

The TBS 500 belt sander tilts so that the sanding platten can be either horizontal or vertical. The optional bobbin attachment fits to the belt sander. The machine has no-volt starting and excellent dust porting. (Stand illustrated but not supplied)

- ✓ Sander, Disc, 300mm, #WSM-300
- ✓ Sander, Disc, #HSM-300
- ✓ Sander, Disc, #HSM-300 S
- ✓ Sander, Drum, Hegner, #TWS230
- ✓ Sander, Drum, Belt, #TBS-500
- ✓ Sander, Bobbin, Accessory for, #TBS-500

ITEM	RRP	Ex GST
M1052	1,165.00	1,059.09
M1051	1,799.00	1,635.45
M1050	2,038.00	1,852.73
M1094	665.00	604.55
M1043	2,995.00	2,722.73
A4131	372.00	338.18

M1052



M1094



M1050



M1043



A4131



M1051

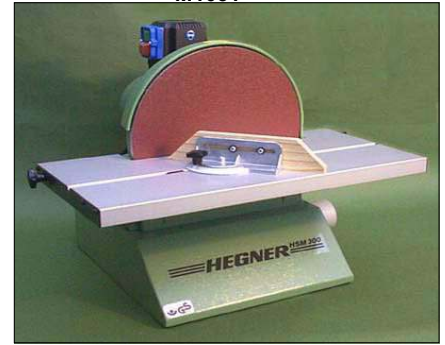

BENCH PLANE SPARE PARTS

For several years spares for Stanley planes for been only intermittently available and in many cases only in quite extensive kits. In addition to these kits we now can offer some parts to the component level for all other than Y levers, lateral adjust levers and frog clips all of which require the purchase of a full frog assembly.

Spares

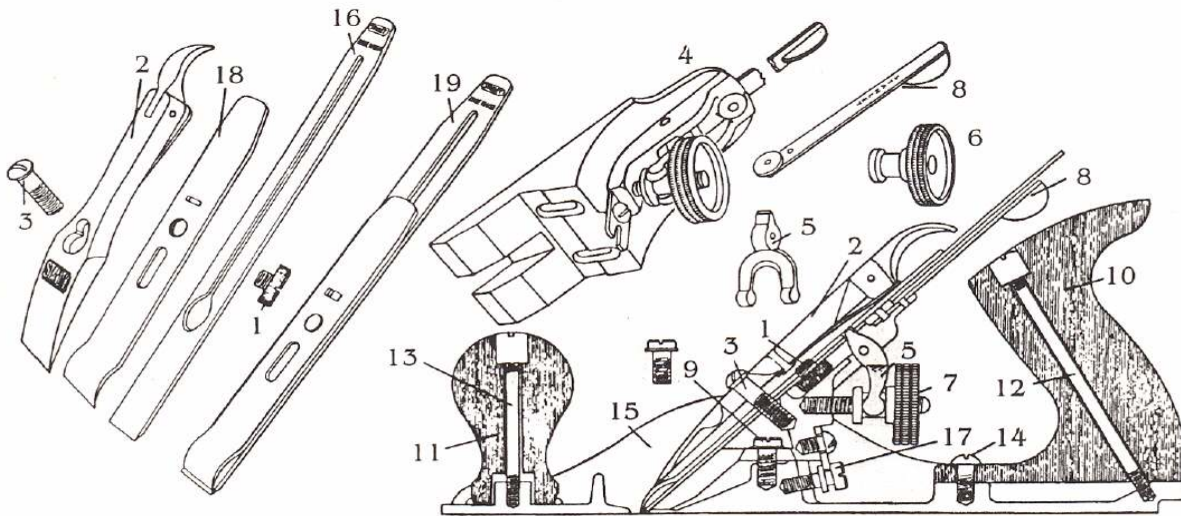

1	Cap screw	6	Adjusting nut	11	Knob	16	Cutting iron
2	Lever cap	7	Adjusting nut screw	12	Handle bolt & nut	17	Frog adjusting screw
3	Lever cap screw	8	Lateral adjusting screw	13	Knob bolt & nut	18	Back iron
4	Frog complete	9	Frog screw	14	Handle screw		
5	"Y" adjusting lever	10	Handle	15	Plan body		

SPARES KITS

- ✓ No: 1, Handle & Knob, for #3, #4
- ✓ No: 2, Handle & Knob, for #4 1/2, #5, #5 1/2, #6, #7
- ✓ No: 3, Bench Plane Fasteners
- ✓ No: 5, Frog Kit for #4, #5
- ✓ No: 8, Lever Cap for #4, #5
- ✓ No: 9, Lever Cap for #4 1/2, #5 1/2, #8, #7
- ✓ No: 12-322, Back Iron & Blade Assembly, for #3
- ✓ No: 12-323, Back Iron & Blade Assembly, for #4, #5
- ✓ No: 12-325, Back Iron & Blade Ass, for #4 1/2, 5 1/2, 6, 7

ITEM	RRP	Ex GST	PART
S2980	25.64	23.31	10,12,14,11,13
S2981	25.98	23.62	10,12,14,11,13
S2983	32.54	29.58	Set of Stanley & Metric.
S2984	83.18	75.62	4
S2987	41.50	37.73	2
S2988	68.30	62.09	2
S2989	33.28	30.25	1,16,18
S2990	33.80	30.73	1,16,18
S2991	35.88	32.62	1,16,18

SPARES INDIVIDUALLY - (NOTE: ALL STANLEY THREAD, VERY NEW PLANES MAY BE METRIC)

✓ Screw & Nut, Handle, #3 to #4, #P78987	S3005	6.50	5.91	12
✓ Screw & Nut, Handle, #4.5 to #7, #P78995	S3006	6.50	5.91	12
✓ Screw & Nut, Knob, #3 & #4, #P79026	S3007	6.50	5.91	13
✓ Screw & Nut, Knob, #4.5 to #7, #P79034	S3008	6.50	5.91	13
✓ Screw, Toe, #P36396	S3010	8.12	7.38	14
✓ Screw, Frog Mounting, and Washer, #P78979	S3011	4.00	3.64	9
✓ Screw, Lever Cap, #P33066	S3012	6.50	5.91	3
✓ Screw, Cap/Back Iron, #3 to #7, #P33009	S3013	6.00	5.45	1
✓ Screw, Frog Adjusting, #P32864	S3014	6.50	5.91	17
✓ Nut, Adjusting, #P34419	S3016	12.50	11.36	6
✓ Screw, Adjusting Nut, #P34427	S3017	6.00	5.45	7

✓ Cap, Lever, #4 & #5, #P73948	S2987	41.50	37.73	2
✓ Cap, Lever, #4.5 to #7, #P73964	S2988	68.30	62.09	2
✓ Back Iron, with screw, 45mm, #3, #P12002	S2989	33.28	30.25	18
✓ Back Iron, with screw, 50mm, #4, #5, #P12003	S2990	33.80	30.73	18
✓ Back Iron & screw, 60mm, #4 1/2, 5 1/2, 6, 7, #P12004	S2991	35.88	32.62	18

THREADED INSERTS FOR WOOD - SOLID BRASS

✓ Insert, Threaded, Brass, 3mm, pair	H3900	3.85	3.50
✓ Insert, Threaded, Brass, 3mm, dozen	H3901	13.85	12.59
✓ Insert, Threaded, Brass, 4mm, pair	H3902	4.06	3.69
✓ Insert, Threaded, Brass, 4mm, dozen	H3903	14.62	13.29
✓ Insert, Threaded, Brass, 5mm, pair	H3914	4.13	3.76
✓ Insert, Threaded, Brass, 5mm, dozen	H3915	14.88	13.53
✓ Insert, Threaded, Brass, 6mm, pair	H3904	5.36	4.87
✓ Insert, Threaded, Brass, 6mm, dozen	H3905	19.29	17.54
✓ Insert, Threaded, Brass, 8mm, pair	H3906	7.23	6.57
✓ Insert, Threaded, Brass, 8mm, dozen	H3907	26.01	23.65
✓ Insert, Threaded, Brass, 1/4 inch, pair	H3908	5.54	5.04
✓ Insert, Threaded, Brass, 1/4 inch, dozen	H3909	19.94	18.13
✓ Insert, Threaded, Brass, 5/16 inch, pair	H3910	5.54	5.04
✓ Insert, Threaded, Brass, 5/16 inch, dozen	H3911	19.94	18.13
✓ Insert, Threaded, Brass, 3/8 inch, pair	H3912	7.23	6.57
✓ Insert, Threaded, Brass, 3/8 inch, dozen	H3913	26.01	23.65

H3900



BRUSSO BOX AND CABINET HARDWARE

Wood Works supplies a range of box and cabinet hardware made in the USA by the Brusso Corporation. More complete descriptions can be found on our website - search using the word brusso. Note the majority of the range is also available in stainless steel.

PIVOT HINGES - OFFSET - BRASS

✓ 33.34mm x 7.94mm leaf, Pair, #L-23	H7060	39.00	35.45
✓ 44.45mm x 9.53mm leaf, Pair, #L-37	H7062	46.00	41.82
✓ Long Knuckle, 44.45mm x 9.53mm leaf, Pair, #L-39	H7064	48.80	44.36
✓ Brass, 50.80mm x 12.7mm leaf, Pair, #L-87	H7066	62.80	57.09

H7060



PIVOT HINGES - INLINE - BRASS

✓ 33.34mm x 7.94mm leaf, Pair, #ST-12	H7090	27.33	24.85
✓ 44.45mm x 9.53mm leaf, Pair, #ST-18	H7092	38.00	34.55
✓ 50.80mm x 12.7mm leaf, Pair, #ST-80	H7094	50.20	45.64

H7090



BUTT HINGES - BRASS

✓ Lift Off, 63.50mm x 44.45mm, LEFT HAND, Pair	H7120	54.67	49.70
✓ Lift Off, 63.50mm x 44.45mm, RIGHT HAND, Pair	H7121	54.67	49.70
✓ Triple Knuckle with Finial, 63.50mm x 44.45mm, Pair	H7122	97.11	88.28
✓ Full Mortise, 63.50mm x 46.04mm, Pair	H7123	36.91	33.55
✓ With Finial, Full Mortise, 63.50mm x 46.04mm, Pair	H7125	43.20	39.27
✓ Full Mortise, 63.50mm x 20.64mm, Pair	H7127	50.67	46.06
✓ With Finial, Full Mortise, 31.75mm x 20.64mm, Pair	H7129	53.33	48.48
✓ Full Mortise, 31.75mm x 26.99mm, Pair	H7131	56.00	50.91
✓ With Finial, Full Mortise, 31.75mm x 31.75mm, Pair	H7133	58.67	53.33
✓ Full Mortise, 50.8mm x 38.10mm, Pair	H7135	71.20	64.73
✓ Butt with Finial, Full Mortise, 50.8mm x 38.10mm, Pair	H7137	75.40	68.55

H7125



H7150



BOX FEET - BRASS

✓ 12.7mm diam., Proj. 9.53 mm, Pin diam 7.94 mm, 4 pcs	H7150	21.51	19.55
✓ 19.05mm diam., Proj. 14.29 mm, Pin diam.12.7mm, 4 pcs	H7152	42.51	38.64
✓ 25.40mm diam., Proj. 3.18 mm, Pin diam. 15.88 mm	H7154	32.00	29.09
✓ 12.70mm diam., Proj. 23.81mm, Pin diam. 9.53 mm, 4 pcs	H7156	40.00	36.36
✓ 22.23 x 22.23mm, Thickness 6mm , 4 pcs	H7158	35.51	32.28

H7180



BOX HINGES - BRASS - BUTT - 95 deg STAYED

✓ 19.05mm long x 12.70mm wide, Pair, #JB-101	H7180	38.31	34.82
✓ 31.75mm long x 12.70mm wide, Pair, #JB-102	H7182	41.11	37.37
✓ 31.75mm long x 15.88mm wide, Pair, #JB-103	H7184	43.91	39.92
✓ 50.80mm long x 22.23mm wide, Pair, #JB-107	H7186	74.00	67.27
✓ 31.75mm long x 25.40mm wide, Pair, #JB-804	H7188	48.11	43.73

BOX HOOKS - BRASS

- ✓ 9.53mm diam., Proj. 23.81 mm, Pin diam.4.76mm, Ea.
- ✓ 41.28mm diam., Proj. 28.58 mm, Pin diam. 9.53mm, Ea.

H7220	12.40	11.27
H7222	57.33	52.12

H7220**H7222****HANGING BRACKETS**

- ✓ Bracket, Hanging, Brass, 38.10mm x 15.88mm, Pair

H7240	23.33	21.21
--------------	--------------	--------------

H7240**H7260****BOX KNOBS - SOLID BRASS**

- ✓ 7.94mm diam., 7.94mm Proj., with 4.76mm pin, Each
- ✓ 11.11mm diam., 9.53mm Proj., with 4.76mm pin, Each
- ✓ 14.29mm diam., 12.70mm Proj., with 7.94mm pin, Each
- ✓ 17.46mm diam., 15.88mm Proj., with 9.53mm pin, Each

H7260	11.60	10.55
H7262	12.67	11.52
H7264	14.00	12.73
H7266	19.33	17.58

**BOX LID STAYS - BRASS - PRICE FOR EACH**

- ✓ 73.03 x 6.35mm Body, 12.70mm deep, Anchor pin 6.35mm
- ✓ 109.54x9.53mm Body, 19.05mm deep, Anchor pin 11.11mm

H7280	38.00	34.55
H7281	59.31	53.92

H7280**BOX QUADRANT HINGES - BRASS**

- ✓ Stayed at 95 degrees, each leaf 25.40mm x 25.40mm, Pair
- ✓ Stayed at 95 degrees, each leaf 38.10mm x 44.45mm, Pair

H7290	65.60	59.64
H7291	95.00	86.36

**SHELF PINS & SOCKETS - BRASS**

- ✓ Socket, 3/8 in. (9.53mm) dia.x 7/16 in.(11.11mm), per Doz.
- ✓ Pin, 1/4 inch (6.35mm) diam.x3/8 inch (9.53mm), per 4

H7310	34.80	31.64
H7312	22.91	20.82

H7290**LATCHES & CATCHES - BRASS**

- ✓ Latch, Mortise, Brass, 50.80mm x 19.05mm, Ea.
- ✓ Catch, Ball, Brass, with Keeper, 6.35mm diam., Ea.
- ✓ Catch, Ball, Brass, with Keeper, 8.73mm diam., Ea.
- ✓ Catch, Ball, Brass, with Keeper, 11.11mm diam., Ea.

H7330	50.20	45.64
H7332	16.67	15.15
H7334	18.00	16.36
H7336	20.80	18.91

**BOX HARDWARE FITTING TEMPLATES**

- ✓ Template, Each, #TJ-101
- ✓ Template, Each, #TJ-102
- ✓ Template, Each, #TJ-103
- ✓ for HD-638 Quadrant Hinge, Each, #TJ-638
- ✓ for HD-680 Quadrant Hinge, Each, #TJ-680
- ✓ for Series HD-702 Box Feet, Each, #TJ-702
- ✓ for Series JB-804 Series, Each, #TJ-804
- ✓ for Series JB-828 Series Latches, Each, #TJ-828
- ✓ for Series JB-766 Series Pulls, Each, #T-766
- ✓ for Series JB-804 Butt Hinges, Each, #T-804
- ✓ for Series 828 Push Button Latches, Each, #T-828

H7420	54.67	49.70
H7421	54.67	49.70
H7422	54.67	49.70
H7423	54.67	49.70
H7424	54.67	49.70
H7425	54.67	49.70
H7426	54.67	49.70
H7427	54.67	49.70
H7428	54.67	49.70
H7429	54.67	49.70
H7430	54.67	49.70

H7330**ESCUTCHEON PINS- BRASS PLATED STEEL**

- ✓ 6 x 1.5 x 2.5mm Head Diam., 500pcs
- ✓ 8 x 1.5 x 2.5mm Head Diam., 500pcs
- ✓ 10 x 1.5 x 2.5mm Head Diam., 500pcs
- ✓ 13 x 1.5 x 2.65mm Head Diam., 500pcs
- ✓ 16 x 1.5 x 2.85mm Head Diam., 500pcs
- ✓ 19 x 1.5 x 3.0mm Head Diam., 500pcs

ITEM	RRP	Ex GST
H0511	29.98	27.25
H0513	31.27	28.43
H0515	40.64	36.94
H0517	40.64	36.94
H0519	53.14	48.31
H0521	68.75	62.50

Escutcheon Pins**ESCUTCHEON PINS - SOLID BRASS - PACKET 500 pcs**

- ✓ 3.0 x 0.58 x 1.0mm Head Diam, (0 .023 x 1/8)
- ✓ 6.35 x 1.0 x 1.6mm Head Diam, (#20 x 1/4 x 0.063),
- ✓ 6.35 x 1.80 x 3.40mm Head Diam., (#15 x 1/4 x 0.030),
- ✓ 9.5 x 1.00 x 2.25mm Head Diam, (#20 x 3/8 x 0.063),
- ✓ 9.5 x 1.65 x 3.3mm Head Diam, (#16 x 3/8 x 0.130),
- ✓ 9.5 x 2.1 x 4.0mm Head Diam, (#14 x 3/8 x 0.150),
- ✓ 12 x 2.0 x 4.0mm Head Diam.,
- ✓ 12.5 x 1.2 x 2.5mm Head Diam., (#18 x 1/2),
- ✓ 12.5 x 1.6 x 3.3mm Head Diam., (#16 x 1/2),
- ✓ 12.7 x 1.0 x 1.6mm Head Diam, (#20 x 1/2 x 0.063),
- ✓ 12.7 x 1.25 x 2.25mm Head Diam, (#18 x 1/2 x 0.086),
- ✓ 13.5 x 1.15 x 3.3mm Head Diam, (#16 x 1/2 x 0.130),

ITEM	RRP	Ex GST
H0670	12.63	11.48
H0672	31.68	28.80
H0676	47.28	42.98
H0678	34.88	31.71
H0682	39.04	35.49
H0684	51.60	46.91
H0686	84.66	76.96
H0688	26.61	24.19
H0690	33.58	30.52
H0692	33.68	30.62
H0694	35.80	32.55
H0696	38.60	35.09

✓ 12.7 x 1.25 x 2.25mm Head Diam, (#14 x 1/2 x 0.150),	H0698	44.16	40.15
✓ 14 x 2.0 x 4.0mm Head Diam.,	H0700	95.13	86.48
✓ 16.0 x 1.25 x 2.25mm Head Diam, (#18 x 5/8 x 0.086),	H0702	48.00	43.64
✓ 17.0 x 1.6 x 3.3mm Head Diam., (#16 x 5/8),	H0706	39.85	36.23
✓ 17.0 x 2.0 x 4.3mm Head Diam., (#14 x 5/8),	H0708	67.08	60.98
✓ 19.0 x 1.00 x 2.25mm Head Diam, (#20 x 3/4 x 0.063),	H0710	47.52	43.20
✓ 19.0 x 1.25 x 2.25mm Head Diam, (#18 x 3/4 x 0.086),	H0712	78.48	71.35
✓ 19.0 x 1.65 x 3.3mm Head Diam, (#16 x 3/4 x 0.130),	H0714	93.12	84.65
✓ 20.5 x 1.2 x 2.5mm Head Diam., (#18 x 3/4),	H0716	34.57	31.42
✓ 20.5 x 2.0 x 4.3mm Head Diam., (#14 x 3/4),	H0718	68.40	62.18
✓ 21.0 x 1.6 x 3.3mm Head Diam., (#16 x 3/4),	H0720	60.44	54.94
✓ 25.4 x 1.2 x 2.5mm Head Diam., (#18 x 1),	H0724	60.27	54.79
✓ 27.0 x 2.0 x 4.3mm Head Diam., (#14 x 1),	H0726	80.96	73.60
✓ 27.0 x 1.6 x 3.3mm Head Diam., (#16 x 1),	H0728	79.26	72.06
✓ 33.5 x 1.6 x 3.3mm Head Diam., (#16 1 1/4),	H0732	95.00	86.36
✓ 33.5 x 2.0 x 4.3mm Head Diam., (#14 x 1 1/4),	H0734	111.92	101.75

ESCUTCHEON PINS - NICKEL PLATED BRASS - 500 pc:

	ITEM	RRP	Ex GST
✓ 6.35 x 1.0 x 1.6mm Head Diam, (#20 x 1/4 x 0.063)	H0651	32.64	29.67
✓ 6.35 x 1.80 x 2.6mm Head Diam, (#15 x 1/4 x 0.030)	H0653	62.72	57.02
✓ 9.8 x 1.00 x 2.4mm Head Diam, (#20 x 3/8 x 0.063)	H0655	80.40	73.09
✓ 9.8 x 1.25 x 2.2mm Head Diam, (#18 x 3/8 x 0.086)	H0657	80.40	73.09
✓ 12.5 x 1.25 x 2.2mm Head Diam, (#18 x 1/2 x 0.086)	H0659	90.24	82.04



WOODSCREWS - BRASS COUNTERSUNK SLOTTED HEAD

Made in USA, cut thread woodscrews of a quality once taken for granted.

	ITEM	RRP	Ex GST
✓ 2 Gauge x 1/4 inch (6mm), Box 100pcs	H8300	11.98	10.89
✓ 2 Gauge x 3/8 inch (10mm), Box 100pcs	H8301	14.90	13.55
✓ 2 Gauge x 1/2 inch (12mm), Box 100pcs	H8302	14.60	13.27
✓ 2 Gauge x 3/4 inch (19mm), Box 100pcs	H8303	16.75	15.23
✓ 3 Gauge x 3/8 inch (10mm), Box 100pcs	H8305	17.80	16.18
✓ 3 Gauge x 1/2 inch (12mm), Box 100pcs	H8306	19.38	17.61
✓ 3 Gauge x 5/8 inch (16mm), Box 100pcs	H8307	15.80	14.36
✓ 3 Gauge x 3/4 inch (19mm), Box 100pcs	H8308	14.65	13.32
✓ 4 Gauge x 3/8 inch (10mm), Box 100pcs	H8310	15.45	14.05
✓ 4 Gauge x 1/2 inch (12mm), Box 100pcs	H8311	21.60	19.64
✓ 4 Gauge x 5/8 inch (16mm), Box 100pcs	H8312	15.70	14.27
✓ 4 Gauge x 3/4 inch (19mm), Box 100pcs	H8313	17.90	16.27
✓ 4 Gauge x 7/8 inch (22mm), Box 100pcs	H8314	20.40	18.55
✓ 4 Gauge x 1 1/4 inch (32mm), Box 100pcs	H8315	22.25	20.23
✓ 5 Gauge x 1/2 inch (12mm), Box 100pcs	H8317	16.75	15.23
✓ 5 Gauge x 5/8 inch (16mm), Box 100pcs	H8318	19.25	17.50
✓ 5 Gauge x 1 inch (25mm), Box 100pcs	H8319	25.88	23.52
✓ 6 Gauge x 3/8 inch (10mm), Box 100pcs	H8321	27.33	24.84
✓ 6 Gauge x 5/8 inch (16mm), Box 100pcs	H8322	25.15	22.86
✓ 6 Gauge x 3/4 inch (19mm), Box 100pcs	H8323	28.30	25.73
✓ 6 Gauge x 1 inch (25mm), Box 100pcs	H8324	39.33	35.75
✓ 6 Gauge x 1 1/4 inch (32mm), Box 100pcs	H8325	41.70	37.91
✓ 6 Gauge x 1 1/2 inch (38mm), Box 100pcs	H8326	42.75	38.86
✓ 6 Gauge x 1 3/4 inch (44.5mm), Box 100pcs	H8327	54.30	49.36
✓ 6 Gauge x 2 inch (50mm), Box 100pcs	H8328	55.38	50.34
✓ 8 Gauge x 3/8 inch (10mm), Box 100pcs	H8330	27.33	24.84
✓ 8 Gauge x 1/2 inch (12mm), Box 100pcs	H8331	25.15	22.86
✓ 8 Gauge x 3/4 inch (19mm), Box 100pcs	H8332	28.30	25.73
✓ 8 Gauge x 1 inch (25mm), Box 100pcs	H8333	39.33	35.75
✓ 8 Gauge x 1 1/4 inch (32mm), Box 100pcs	H8334	41.70	37.91
✓ 8 Gauge x 1 1/2 inch (38mm), Box 100pcs	H8335	42.75	38.86
✓ 8 Gauge x 2 inch (50mm), Box 100pcs	H8336	54.30	49.36

Countersunk Slotted



✓ 10 Gauge x 5/8 inch (10mm), Box 100pcs	H8338	21.85	19.86
✓ 10 Gauge x 3/4 inch (19mm), Box 100pcs	H8339	57.08	51.89
✓ 10 Gauge x 1 inch (25mm), Box 100pcs	H8340	48.78	44.34
✓ 10 Gauge x 1 1/4 inch (32mm), Box 100pcs	H8341	66.90	60.82
✓ 10 Gauge x 1 1/2 inch (38mm), Box 100pcs	H8342	63.48	57.70
✓ 10 Gauge x 2 inch (50mm), Box 100pcs	H8343	64.53	58.66

✓ 12 Gauge x 1 inch (25mm), Box 100pcs	H8345	42.48	38.61
✓ 12 Gauge x 1 1/2 inch (38mm), Box 100pcs	H8346	80.45	73.14
✓ 12 Gauge x 2 1/2 inch (63mm), Box 100pcs	H8347	141.95	129.05

✓ 14 Gauge x 1 inch (25mm), Box 100pcs	H8349	93.75	85.23
✓ 14 Gauge x 1 1/4 inch (32mm), Box 100pcs	H8350	92.58	84.16
✓ 14 Gauge x 1 1/2 inch (38mm), Box 100pcs	H8351	104.70	95.18
✓ 14 Gauge x 2 inch (50mm), Box 100pcs	H8352	116.55	105.95
✓ 14 Gauge x 2 1/4 inch (56mm), Box 100pcs	H8353	66.75	60.68
✓ 14 Gauge x 2 1/2 inch (63mm), Box 100pcs	H8354	117.80	107.09
✓ 14 Gauge x 3 inch (75mm), Box 100pcs	H8355	84.20	76.55

WOODSCREWS - BRASS COUNTERSUNK PHILLIPS HE

	ITEM	RRP	Ex GST
✓ 2G x 1/2 inch (12.5mm), Box 100pcs	H8450	14.65	13.32
✓ 3G x 1/2 inch (12.5mm), Box 100pcs	H8452	14.80	13.45
✓ 4G x 3/8 inch (10mm), Box 100pcs	H8454	14.13	12.84
✓ 4G x 1/2 inch (12.5mm), Box 100pcs	H8455	14.80	13.45
✓ 4G x 3/4 inch (19mm), Box 100pcs	H8456	15.45	14.05
✓ 5G x 1/2 inch (12.5mm), Box 100pcs	H8458	21.28	19.34
✓ 5G x 5/8 inch (16mm), Box 100pcs	H8459	18.60	16.91
✓ 5G x 1 inch (25.4mm), Box 100pcs	H8460	25.30	23.00
✓ 6G x 1/2 inch (12.5mm), Box 100pcs	H8462	16.50	15.00
✓ 6G x 5/8 inch (16mm), Box 100pcs	H8463	18.38	16.70
✓ 6G x 3/4 inch (19mm), Box 100pcs	H8464	21.20	19.27
✓ 6G x 1 inch (25.4mm), Box 100pcs	H8465	27.78	25.25
✓ 6G x 1 1/4 inch (32mm), Box 100pcs	H8466	31.65	28.77
✓ 8G x 3/4 inch (19mm), Box 100pcs	H8468	29.35	26.68
✓ 8G x 1 inch (25.4mm), Box 100pcs	H8469	31.98	29.07
✓ 8G x 1 1/4 inch (32mm), Box 100pcs	H8470	41.20	37.45
✓ 8G x 1 1/2 inch (38mm), Box 100pcs	H8471	48.78	44.34
✓ 10G x 3/4 inch (19.5mm), Box 100pcs	H8473	34.08	30.98
✓ 10G x 1 1/4 inch (32mm), Box 100pcs	H8474	57.45	52.23
✓ 10G x 1 3/4 inch (44.5mm), Box 100pcs	H8475	70.08	63.70
✓ 10G x 2 inch (50mm), Box 100pcs	H8476	53.50	48.64
✓ 12G x 2 1/2 inch (63.5mm), Box 100pcs	H8478	144.28	131.16

WOODSCREWS - BRASS RAISED / CSK SLOTTED HEA

	ITEM	RRP	Ex GST
✓ 3G x 3/8 inch (10mm), Box 100pcs	H8695	13.80	12.55
✓ 3G x 1/2 inch (12mm), Box 100pcs	H8696	15.78	14.34
✓ 4G x 3/8 inch (10mm), Box 100pcs	H8698	18.68	16.98
✓ 4G x 1/2 inch (12mm), Box 100pcs	H8699	13.85	12.59
✓ 4G x 5/8 inch (16mm), Box 100pcs	H8700	15.18	13.80
✓ 4G x 3/4 inch (19mm), Box 100pcs	H8701	20.43	18.57
✓ 4G x 1 inch (25.4mm), Box 100pcs	H8702	19.83	18.02
✓ 4G x 1 1/4inch (32mm), Box 100pcs	H8703	27.50	25.00
✓ 6G x 5/8 inch (16mm), Box 100pcs	H8705	32.30	29.36
✓ 6G x 3/4 inch (19mm), Box 100pcs	H8706	25.60	23.27
✓ 6G x 1 1/4inch (32mm), Box 100pcs	H8707	30.93	28.11
✓ 7G x 1 1/4inch (32mm), Box 100pcs	H8709	27.05	24.59

Countersunk Phillips



Raised Countersunk Slotted



- ✓ 8G x 1/2 inch (12mm), Box 100pcs
- ✓ 8G x 5/8 inch (16mm), Box 100pcs
- ✓ 8G x 3/4 inch (19mm), Box 100pcs
- ✓ 8G x 7/8 inch (22mm), Box 100pcs
- ✓ 8G x 1 inch (25.4mm), Box 100pcs
- ✓ 8G x 1 1/4inch (32mm), Box 100pcs
- ✓ 8G x 1 1/2inch (38mm), Box 100pcs

H8711	29.35	26.68
H8712	28.78	26.16
H8713	31.98	29.07
H8714	36.63	33.30
H8715	41.63	37.84
H8716	43.80	39.82
H8717	46.15	41.95

- ✓ 10G x 5/8 inch (16mm), Box 100pcs
- ✓ 10G x 3/4 inch (19mm), Box 100pcs
- ✓ 10G x 1 inch (25.4mm), Box 100pcs
- ✓ 10G x 1 1/2inch (32mm), Box 100pcs
- ✓ 10G x 2inch (50mm), Box 100pcs
- ✓ 10G x 3inch (75mm), Box 100pcs

H8719	48.40	44.00
H8720	35.13	31.93
H8721	44.63	40.57
H8722	57.95	52.68
H8723	79.75	72.50
H8724	87.10	79.18

- ✓ 12G x 1 inch (25.4mm), Box 100pcs
- ✓ 12G x 1 1/4inch (32mm), Box 100pcs
- ✓ 12G x 2inch (50mm), Box 100pcs
- ✓ 12G x 3inch (75mm), Box 100pcs

H8726	77.58	70.52
H8727	78.45	71.32
H8728	111.93	101.75
H8729	213.00	193.64

- ✓ 14G x 1 1/2inch (32mm), Box 100pcs
- ✓ 14G x 2inch (50mm), Box 100pcs

H8731	101.25	92.05
H8732	136.63	124.20

WOODSCREWS - BRASS ROUND SLOTTED HEAD

- ✓ 2G x 1/4 inch (6mm), Box 100pcs
- ✓ 2G x 3/8 inch (10mm), Box 100pcs
- ✓ 2G x 1/2 inch (12mm), Box 100pcs

ITEM	RRP	Ex GST
H8840	17.80	16.18
H8841	14.38	13.07
H8842	15.55	14.14

- ✓ 3G x 1/2 inch (12mm), Box 100pcs

H8844	17.50	15.91
-------	-------	-------

- ✓ 4G x 3/8 inch (10mm), Box 100pcs
- ✓ 4G x 5/8 inch (16mm), Box 100pcs
- ✓ 4G x 3/4 inch (19mm), Box 100pcs

H8846	14.65	13.32
H8847	15.18	13.80
H8848	20.15	18.32

- ✓ 6G x 1/2 inch (12mm), Box 100pcs
- ✓ 6G x 1 inch (25mm), Box 100pcs

H8850	18.85	17.14
H8851	28.48	25.89

- ✓ 8G x 5/8 inch (16mm), Box 100pcs
- ✓ 8G x 3/4 inch (19mm), Box 100pcs
- ✓ 8G x 1 inch (25mm), Box 100pcs
- ✓ 8G x 1 1/4 inch (32mm), Box 100pcs
- ✓ 8G x 1 1/2 inch (38mm), Box 100pcs
- ✓ 8G x 1 3/4 inch (44mm), Box 100pcs
- ✓ 8G x 2 inch (50mm), Box 100pcs

H8853	28.20	25.64
H8854	32.25	29.32
H8855	34.85	31.68
H8856	42.75	38.86
H8857	64.00	58.18
H8858	55.93	50.84
H8859	65.15	59.23

- ✓ 10G x 1/2 inch (12mm), Box 100pcs
- ✓ 10G x 5/8 inch (16mm), Box 100pcs
- ✓ 10G x 3/4 inch (19mm), Box 100pcs
- ✓ 10G x 7/8 inch (22mm), Box 100pcs
- ✓ 10G x 1 inch (25mm), Box 100pcs
- ✓ 10G x 1 1/4 inch (32mm), Box 100pcs
- ✓ 10G x 1 3/4 inch (44mm), Box 100pcs
- ✓ 10G x 2 inch (50mm), Box 100pcs

H8861	35.58	32.34
H8862	27.63	25.11
H8863	29.93	27.20
H8864	49.85	45.32
H8865	39.18	35.61
H8866	52.70	47.91
H8867	98.65	89.68
H8868	78.45	71.32

- ✓ 12G x 5/8 inch (16mm), Box 100pcs
- ✓ 12G x 1 inch (25mm), Box 100pcs
- ✓ 12G x 1 1/4 inch (32mm), Box 100pcs
- ✓ 12G x 2 inch (50mm), Box 100pcs
- ✓ 12G x 2 1/2 inch (62mm), Box 100pcs

H8870	28.25	25.68
H8871	79.03	71.84
H8872	72.65	66.05
H8873	105.48	95.89
H8874	123.48	112.25

Round Head Slotted



BRASS NUTS, BOLTS, SETSCREWS & WASHERS

BRASS SETSCREW - COUNTERSUNK SLOTTED HEAD

	ITEM	RRP	Ex GST
✓ M4 x 16 x 0.7mm pitch, 12 pcs	H2300	8.95	8.14
✓ M4 x 25 x 0.7mm pitch, 12 pcs	H2301	9.15	8.32
✓ M4 x 40 x 0.7mm pitch, 12 pcs	H2302	10.36	9.42
✓ M4 x 50 x 0.7mm pitch, 12 pcs	H2303	12.35	11.23
✓ M5 x 20 x 0.8mm pitch, 12 pcs	H2304	9.90	9.00
✓ M5 x 25 x 0.8mm pitch, 12 pcs	H2305	10.54	9.58
✓ M6 x 20 x 1mm pitch, 12 pcs	H2306	11.23	10.21
✓ M6 x 25 x 1mm pitch, 12 pcs	H2307	14.21	12.92
✓ M6 x 30 x 1mm pitch, 12 pcs	H2308	16.39	14.90
✓ M6 x 40 x 1mm pitch, 12 pcs	H2309	21.87	19.88
✓ M8 x 20 x 1.25 pitch, 12 pcs	H2310	34.66	31.51
✓ M8 x 25 x 1.25 pitch, 12 pcs	H2311	37.15	33.77

Countersunk Slotted



BRASS SETSCREW - HEX HEAD

	ITEM	RRP	Ex GST
✓ M4 x 16 x 0.7mm pitch, 12 pcs	H2400	8.95	8.14
✓ M5 x 10 x 0.8mm pitch, 12 pcs	H2401	9.30	8.45
✓ M5 x 12 x 0.8mm pitch, 12 pcs	H2402	9.95	9.05
✓ M5 x 16 x 0.8mm pitch, 12 pcs	H2403	11.10	10.09
✓ M5 x 20 x 0.8mm pitch, 12 pcs	H2404	14.07	12.79
✓ M5 x 25 x 0.8mm pitch, 12 pcs	H2405	18.41	16.74
✓ M5 x 30 x 0.8mm pitch, 12 pcs	H2406	17.98	16.35
✓ M6 x 10 x 1mm pitch, 12 pcs	H2407	14.60	13.27
✓ M6 x 12 x 1mm pitch, 12 pcs	H2408	15.11	13.74
✓ M6 x 16 x 1mm pitch, 12 pcs	H2409	16.85	15.32
✓ M6 x 20 x 1mm pitch, 12 pcs	H2410	17.47	15.88
✓ M6 x 30 x 1mm pitch, 12 pcs	H2411	21.10	19.18
✓ M6 x 35 x 1mm pitch, 12 pcs	H2412	20.43	18.57
✓ M6 x 40 x 1mm pitch, 12 pcs	H2413	25.00	22.73
✓ M6 x 50 x 1mm pitch, 12 pcs	H2414	24.71	22.46
✓ M8 x 12 x 1.25mm pitch, 12 pcs	H2415	19.98	18.16
✓ M8 x 16 x 1.25mm pitch, 12 pcs	H2416	22.82	20.75
✓ M8 x 20 x 1.25mm pitch, 12 pcs	H2417	25.30	23.00
✓ M8 x 25 x 1.25mm pitch, 12 pcs	H2418	27.82	25.29
✓ M8 x 30 x 1.25mm pitch, 12 pcs	H2419	38.32	34.84
✓ M8 x 35 x 1.25mm pitch, 12 pcs	H2420	35.10	31.91
✓ M8 x 40 x 1.25mm pitch, 12 pcs	H2421	38.50	35.00
✓ M8 x 50 x 1.25mm pitch, 12 pcs	H2422	45.70	41.55
✓ M10 x 16 x 1.5mm pitch, 12 pcs	H2423	36.79	33.45
✓ M10 x 20 x 1.5mm pitch, 12 pcs	H2424	38.15	34.68
✓ M10 x 25 x 1.5mm pitch, 12 pcs	H2425	44.70	40.64
✓ M10 x 30 x 1.5mm pitch, 12 pcs	H2426	76.06	69.15
✓ M10 x 35 x 1.5mm pitch, 12 pcs	H2427	55.86	50.78
✓ M10 x 40 x 1.5mm pitch, 12 pcs	H2428	62.29	56.63
✓ M10 x 45 x 1.5mm pitch, 12 pcs	H2429	52.11	47.37
✓ M10 x 50 x 1.5mm pitch, 12 pcs	H2430	61.39	55.81
✓ M10 x 75 x 1.5mm pitch, 12 pcs	H2431	75.25	68.41
✓ M12 x 25 x 1.75mm pitch, 12 pcs	H2432	89.04	80.95
✓ M12 x 30 x 1.75mm pitch, 12 pcs	H2433	85.46	77.69
✓ M12 x 35 x 1.75mm pitch, 12 pcs	H2434	91.25	82.95

Hex Head



BRASS SETSCREW - CHEESE SLOTTED HEAD

	ITEM	RRP	Ex GST
✓ M3 x 6 x 0.5 pitch, 12 pcs	H2500	3.34	3.04
✓ M3 x 10 x 0.5 pitch, 12 pcs	H2501	4.09	3.72
✓ M3 x 12 x 0.5 pitch, 12 pcs	H2502	4.32	3.93
✓ M3 x 16 x 0.5 pitch, 12 pcs	H2503	4.49	4.08
✓ M4 x 8 x 0.7 pitch, 12 pcs	H2504	5.26	4.78
✓ M4 x 10 x 0.7 pitch, 12 pcs	H2505	5.49	4.99
✓ M4 x 12 x 0.7 pitch, 12 pcs	H2506	5.52	5.02
✓ M4 x 16 x 0.7 pitch, 12 pcs	H2507	5.70	5.18
✓ M4 x 25 x 0.7 pitch, 12 pcs	H2508	7.51	6.83
✓ M5 x 20 x 0.8 pitch, 12 pcs	H2509	12.30	11.18
✓ M5 x 25 x 0.8 pitch, 12 pcs	H2510	16.14	14.67
✓ M5 x 50 x 0.8 pitch, 12 pcs	H2511	28.99	26.35

Cheese Head Slotted



BRASS NUTS

- ✓ Nut, Full, Solid Brass, Hexagonal, M2, 12 pcs
- ✓ Nut, Full, Solid Brass, Hexagonal, M2.5, 12 pcs
- ✓ Nut, Full, Solid Brass, Hexagonal, M3, 12 pcs
- ✓ Nut, Full, Solid Brass, Hexagonal, M4, 12 pcs
- ✓ Nut, Full, Solid Brass, Hexagonal, M5, 12 pcs
- ✓ Nut, Full, Solid Brass, Hexagonal, M6, 12 pcs
- ✓ Nut, Full, Solid Brass, Hexagonal, M8, 12 pcs
- ✓ Nut, Full, Solid Brass, Hexagonal, M10, 12 pcs
- ✓ Nut, Full, Solid Brass, Hexagonal, M12, 12 pcs
- ✓ Nut, Full, Solid Brass, Hexagonal, M16, 12 pcs

ITEM	RRP	Ex GST
H2600	3.20	2.91
H2601	3.60	3.27
H2602	3.40	3.09
H2603	4.15	3.77
H2604	4.60	4.18
H2605	8.65	7.86
H2606	13.04	11.85
H2607	22.37	20.34
H2608	79.96	72.69
H2609	79.96	72.69

Brass Hex Nuts



BRASS WASHERS

- ✓ Washer, Solid Brass, M3, 12 pcs
- ✓ Washer, Solid Brass, M3.5, 12 pcs
- ✓ Washer, Solid Brass, M4, 12 pcs
- ✓ Washer, Solid Brass, M5, 12 pcs
- ✓ Washer, Solid Brass, M6, 12 pcs
- ✓ Washer, Solid Brass, M8, 12 pcs
- ✓ Washer, Solid Brass, M10, 12 pcs
- ✓ Washer, Solid Brass, M12, 12 pcs
- ✓ Washer, Solid Brass, M16, 12 pcs

ITEM	RRP	Ex GST
H2650	2.88	2.62
H2651	3.24	2.95
H2652	3.06	2.78
H2653	3.74	3.40
H2654	4.14	3.76
H2655	7.79	7.08
H2656	10.19	9.26
H2657	18.68	16.98
H2658	20.86	18.96

Brass Washers



CONSUMABLES

ADHESIVES

All our PVA range is made in Australia from quality fresh ingredients.

Our renowned "yellow" PVA has superior strength, good sandability and quick cure.

The crosslinking PVA has the strongest bond of them all.

The White Sandable is an ultra hard cure PVA which cures slowly & allows time for complex glue ups.

- ✓ White Crosslinking PVA, T3275, 500ml, (decant)
- ✓ White Crosslinking PVA, T3275, 1 Litre, (decant)
- ✓ White Crosslinking PVA, T3275, 5 litres, (decant)
- ✓ White Crosslinking PVA, T3275, 20 litres
- ✓ White Sandable PVA, Slow Cure, T3223, 500ml, (decant)
- ✓ White Sandable PVA, Slow Cure, T3223, 1 Litre, (decant)
- ✓ White Sandable PVA, Slow Cure, T3223, 5 Litres (decant)
- ✓ White Sandable PVA, Slow Cure, T3223, 20 Litres
- ✓ Water Resistant, Yellow PVA, T3250, 500ml, (decant)
- ✓ Water Resistant, Yellow PVA, T3250, 1 Litre, (decant)
- ✓ Water Resistant, Yellow PVA, T3250, 5 Litres (decant)
- ✓ Water Resistant, Yellow PVA, T3250, 20 Litres

ITEM	RRP	Ex GST
C0097	12.37	11.24
C0098	15.20	13.82
C0099	54.00	49.09
C0100	190.40	173.09
C0103	11.84	10.77
C0104	14.40	13.09
C0105	50.40	45.82
C0106	176.80	160.73
C0109	11.46	10.42
C0110	13.82	12.56
C0111	47.79	43.45
C0112	166.94	151.76

PVA Glues



ANIMAL PROTEIN GLUE

- ✓ Adhesive, Hide, Pearl Joiners, 1kg
- ✓ Adhesive, Hide, Pearl Joiners, 2kg
- ✓ Adhesive, Hide, Pearl Joiners, 5kg

C0081	19.20	17.45
C0082	35.50	32.27
C0083	84.95	77.23

BISCUITS

- ✓ Biscuits, #0, pkt 100
- ✓ Biscuits, #10, pkt 100
- ✓ Biscuits, #20, pkt 100
- ✓ Biscuits, #0, box 1000
- ✓ Biscuits, #10, box 1000
- ✓ Biscuits, #20, box 1000

ITEM	RRP	Ex GST
C0400	9.90	9.00
C0401	9.90	9.00
C0402	9.90	9.00
C0410	62.70	57.00
C0411	65.00	59.09
C0412	65.00	59.09

Biscuits



FLUTED DOWEL - TASMANIAN OAK - CUT TO LENGTH

- ✓ 6mm x 38mm, 72 grams (approx. 100 pcs)
- ✓ 6mm x 38mm, 720 gms (approx 1000 pcs)
- ✓ 8mm x 44mm, 141 grams (approx 100 pcs)
- ✓ 8mm x 44mm, 1410 grams (approx 1000 pcs)
- ✓ 8mm x 50mm, 158 grams (approx 100 pcs)
- ✓ 8mm x 50mm, 1580 grams (approx. 1000 pcs)
- ✓ 10mm x 44mm, 248 grams (approx 100 pcs)
- ✓ 10mm x 44mm, 2480 grams (approx 1000 pcs)
- ✓ 10mm x 62mm, 349 grams (approx 100 pcs)
- ✓ 10mm x 62mm, 3490 grams (approx 1000 pcs)

C0414	5.76	5.24
C0415	57.59	52.36
C0416	6.56	5.96
C0417	65.61	59.64
C0418	7.46	6.78
C0419	74.56	67.78
C0420	9.36	8.51
C0421	93.57	85.06
C0424	13.19	11.99
C0425	131.86	119.88

Dowels



PUTTY BRICKS - AUSTRALIAN MADE

Ideal for repair of dings & gaps. Boxes of 20 mixed colours, bags of 5 of any one colour & bags of 10 wood tones.

Mixed Boxes

- ✓ 75 x 15 x 15mm, 10 WOOD TONE colours
- ✓ 75 x 15 x 15mm, 20 colours, Range 1, #APB 1
- ✓ 75 x 15 x 15mm, 20 colours, Range 2, #APB 2

C3945	29.98	27.25
C3946	49.95	45.41
C3947	49.95	45.41

Bags of 5 Of One Colour

- ✓ 5 pcs, 75 x 15 x 15mm, Natural, #WPB 11
- ✓ 5 pcs, 75 x 15 x 15mm, White, #WPB 12
- ✓ 5 pcs, 75 x 15 x 15mm, Light Teak, #WPB 13
- ✓ 5 pcs, 75 x 15 x 15mm, Teak, #WPB 14
- ✓ 5 pcs, 75 x 15 x 15mm, Light Walnut, #WPB 15
- ✓ 5 pcs, 75 x 15 x 15mm, Dark Walnut, #WPB 16
- ✓ 5 pcs, 75 x 15 x 15mm, Blackwood, #WPB 17
- ✓ 5 pcs, 75 x 15 x 15mm, Brown Mahogany, #WPB 18
- ✓ 5 pcs, 75 x 15 x 15mm, Mahogany, #WPB 19
- ✓ 5 pcs, 75 x 15 x 15mm, Pine, #WPB 20
- ✓ 5 pcs, 75 x 15 x 15mm, Dark Mahogany, #WPB 21
- ✓ 5 pcs, 75 x 15 x 15mm, Yellow, #WPB 22
- ✓ 5 pcs, 75 x 15 x 15mm, Green, #WPB 23
- ✓ 5 pcs, 75 x 15 x 15mm, Red, #WPB 24
- ✓ 5 pcs, 75 x 15 x 15mm, Hardwood, #WPB 25
- ✓ 5 pcs, 75 x 15 x 15mm, Oak, #WPB 26
- ✓ 5 pcs, 75 x 15 x 15mm, Walnut, #WPB 27
- ✓ 5 pcs, 75 x 15 x 15mm, Charcoal, #WPB 28
- ✓ 5 pcs, 75 x 15 x 15mm, Dark Oak, #WPB 29
- ✓ 5 pcs, 75 x 15 x 15mm, Medium Walnut, #WPB 30
- ✓ 5 pcs, 75 x 15 x 15mm, Grey, #WPB 31
- ✓ 5 pcs, 75 x 15 x 15mm, Light Blue, #WPB 32
- ✓ 5 pcs, 75 x 15 x 15mm, Off White, #WPB 33
- ✓ 5 pcs, 75 x 15 x 15mm, Light Tan, #WPB 34
- ✓ 5 pcs, 75 x 15 x 15mm, Cedar, #WPB 35
- ✓ 5 pcs, 75 x 15 x 15mm, Golden Oak, #WPB 36
- ✓ 5 pcs, 75 x 15 x 15mm, Pale Beige, #WPB 37
- ✓ 5 pcs, 75 x 15 x 15mm, Black, #WPB 38
- ✓ 5 pcs, 75 x 15 x 15mm, Ash Grey, #WPB 39
- ✓ 5 pcs, 75 x 15 x 15mm, Blue Grey, #WPB 40
- ✓ 5 pcs, 75 x 15 x 15mm, Purple Grey, #WPB 41
- ✓ 5 pcs, 75 x 15 x 15mm, Pine Green, #WPB 42
- ✓ 5 pcs, 75 x 15 x 15mm, Baltic, #WPB 43
- ✓ 5 pcs, 75 x 15 x 15mm, Pine Brown, #WPB 44
- ✓ 5 pcs, 75 x 15 x 15mm, Pine Grey, #WPB 45
- ✓ 5 pcs, 75 x 15 x 15mm, Pine Tan, #WPB 46
- ✓ 5 pcs, 75 x 15 x 15mm, Honey Suckle Black, #WPB 47
- ✓ 5 pcs, 75 x 15 x 15mm, Green Grey, #WPB 48
- ✓ 5 pcs, 75 x 15 x 15mm, White Oak, #WPB 49
- ✓ 5 pcs, 75 x 15 x 15mm, Limited Elm, #WPB 50
- ✓ 5 pcs, 75 x 15 x 15mm, Maple, #WPB 51

C3949	14.95	13.59
C3950	14.95	13.59
C3951	14.95	13.59
C3952	14.95	13.59
C3953	14.95	13.59
C3954	14.95	13.59
C3955	14.95	13.59
C3956	14.95	13.59
C3957	14.95	13.59
C3958	14.95	13.59
C3959	14.95	13.59
C3960	14.95	13.59
C3961	14.95	13.59
C3962	14.95	13.59
C3963	14.95	13.59
C3964	14.95	13.59
C3965	14.95	13.59
C3966	14.95	13.59
C3967	14.95	13.59
C3968	14.95	13.59
C3969	14.95	13.59
C3970	14.95	13.59
C3971	14.95	13.59
C3972	14.95	13.59
C3973	14.95	13.59
C3974	14.95	13.59
C3975	14.95	13.59
C3976	14.95	13.59
C3977	14.95	13.59
C3978	14.95	13.59
C3979	14.95	13.59
C3980	14.95	13.59
C3981	14.95	13.59
C3982	14.95	13.59
C3983	14.95	13.59
C3984	14.95	13.59
C3985	14.95	13.59
C3986	14.95	13.59
C3987	14.95	13.59
C3988	14.95	13.59
C3989	14.95	13.59

BOXES of 20 of one colour

- ✓ 20 pcs, 75 x 15 x 15mm, Natural, #WPB 11
- ✓ 20 pcs, 75 x 15 x 15mm, White, #WPB 12
- ✓ 20 pcs, 75 x 15 x 15mm, Light Teak, #WPB 13
- ✓ 20 pcs, 75 x 15 x 15mm, Teak, #WPB 14
- ✓ 20 pcs, 75 x 15 x 15mm, Light Walnut, #WPB 15
- ✓ 20 pcs, 75 x 15 x 15mm, Dark Walnut, #WPB 16
- ✓ 20 pcs, 75 x 15 x 15mm, Blackwood, #WPB 17
- ✓ 20 pcs, 75 x 15 x 15mm, Brown Mahogany, #WPB 18
- ✓ 20 pcs, 75 x 15 x 15mm, Mahogany, #WPB 19
- ✓ 20 pcs, 75 x 15 x 15mm, Pine, #WPB 20
- ✓ 20 pcs, 75 x 15 x 15mm, Dark Mahogany, #WPB 21
- ✓ 20 pcs, 75 x 15 x 15mm, Yellow, #WPB 22
- ✓ 20 pcs, 75 x 15 x 15mm, Green, #WPB 23
- ✓ 20 pcs, 75 x 15 x 15mm, Red, #WPB 24
- ✓ 20 pcs, 75 x 15 x 15mm, Hardwood, #WPB 25

C4092	49.95	45.41
C4093	49.95	45.41
C4094	49.95	45.41
C4095	49.95	45.41
C4096	49.95	45.41
C4097	49.95	45.41
C4098	49.95	45.41
C4099	49.95	45.41
C4100	49.95	45.41
C4101	49.95	45.41
C4102	49.95	45.41
C4103	49.95	45.41
C4104	49.95	45.41
C4105	49.95	45.41
C4106	49.95	45.41

PUTTY 'BRICKS'



✓ 20 pcs, 75 x 15 x 15mm, Oak, #WPB 26	C4107	49.95	45.41
✓ 20 pcs, 75 x 15 x 15mm, Walnut, #WPB 27	C4108	49.95	45.41
✓ 20 pcs, 75 x 15 x 15mm, Charcoal, #WPB 28	C4109	49.95	45.41
✓ 20 pcs, 75 x 15 x 15mm, Dark Oak, #WPB 29	C4110	49.95	45.41
✓ 20 pcs, 75 x 15 x 15mm, Medium Walnut, #WPB 30	C4111	49.95	45.41
✓ 20 pcs, 75 x 15 x 15mm, Grey, #WPB 31	C4112	49.95	45.41
✓ 20 pcs, 75 x 15 x 15mm, Light Blue, #WPB 32	C4113	49.95	45.41
✓ 20 pcs, 75 x 15 x 15mm, Off White, #WPB 33	C4114	49.95	45.41
✓ 20 pcs, 75 x 15 x 15mm, Light Tan, #WPB 34	C4115	49.95	45.41
✓ 20 pcs, 75 x 15 x 15mm, Cedar, #WPB 35	C4116	49.95	45.41
✓ 20 pcs, 75 x 15 x 15mm, Golden Oak, #WPB 36	C4117	49.95	45.41
✓ 20 pcs, 75 x 15 x 15mm, Pale Beige, #WPB 37	C4118	49.95	45.41
✓ 20 pcs, 75 x 15 x 15mm, Black, #WPB 38	C4119	49.95	45.41
✓ 20 pcs, 75 x 15 x 15mm, Ash Grey, #WPB 39	C4120	49.95	45.41
✓ 20 pcs, 75 x 15 x 15mm, Blue Grey, #WPB 40	C4121	49.95	45.41
✓ 20 pcs, 75 x 15 x 15mm, Purple Grey, #WPB 41	C4122	49.95	45.41
✓ 20 pcs, 75 x 15 x 15mm, Pine Green, #WPB 42	C4123	49.95	45.41
✓ 20 pcs, 75 x 15 x 15mm, Baltic, #WPB 43	C4124	49.95	45.41
✓ 20 pcs, 75 x 15 x 15mm, Pine Brown, #WPB 44	C4125	49.95	45.41
✓ 20 pcs, 75 x 15 x 15mm, Pine Grey, #WPB 45	C4126	49.95	45.41
✓ 20 pcs, 75 x 15 x 15mm, Pine Tan, #WPB 46	C4127	49.95	45.41
✓ 20 pcs, 75 x 15 x 15mm, Honey Suckle Black, #WPB 47	C4128	49.95	45.41
✓ 20 pcs, 75 x 15 x 15mm, Green Grey, #WPB 48	C4129	49.95	45.41
✓ 20 pcs, 75 x 15 x 15mm, White Oak, #WPB 49	C4130	49.95	45.41
✓ 20 pcs, 75 x 15 x 15mm, Limited Elm, #WPB 50	C4131	49.95	45.41
✓ 20 pcs, 75 x 15 x 15mm, Maple, #WPB 51	C4132	49.95	45.41

SHELLAC

Cured shellac is safe enough to be rated as a food and offers a quick and safe method of achieving a quality finish on numerous projects.

The best method of ensuring a long shelf life and superior finishes is to use DAA (Denatured Absolute Alcohol) Spirits.

It is important that the DAA can be appropriately stored.

A standard concentrate is simply and quickly made up using a 1 to 4 ratio of dry shellac by weight to DAA spirits by liquid volume e.g. 500gms mixed with 2 litres of DAA.

DAA SPIRITS

- ✓ Spirits, DAA, 100% Industrial Alcohol, 1 litre
- ✓ Spirits, DAA, 100% Industrial Alcohol, 5 litres
- ✓ Spirits, DAA, 100% Industrial Alcohol, 20 litres

ITEM	RRP	Ex GST
C2266	16.95	15.41
C2267	42.95	39.05
C2270	115.58	105.07

DRY SHELLACS

- ✓ Shellac, Orange Flake, Waxy, 250gms
- ✓ Shellac, Orange Flake, Waxy, 500gms
- ✓ Shellac, Orange Flake, Waxy, 1 kilo
- ✓ Shellac, Orange Flake, Waxy, 5 kilo

- ✓ Shellac, Button, Waxy, 250gms
- ✓ Shellac, Button, Waxy, 500gms
- ✓ Shellac, Button, Waxy, 1 kilo
- ✓ Shellac, Button, Waxy, 5 kilo

- ✓ Shellac, Garnet Flake, De-Waxed, 250gms
- ✓ Shellac, Garnet Flake, De-Waxed, 500gms
- ✓ Shellac, Garnet Flake, De-Waxed, 1 kilo
- ✓ Shellac, Garnet Flake, De-Waxed, 5 kilo

- ✓ Shellac, Ruby Flake, De-Waxed 250gms
- ✓ Shellac, Ruby Flake, De-Waxed 500gms
- ✓ Shellac, Ruby Flake, De-Waxed 1 kilo
- ✓ Shellac, Ruby Flake, De-Waxed 5 kilo

- ✓ Shellac, Blonde, De-Waxed, Flake, 250gms
- ✓ Shellac, Blonde, De-Waxed, Flake, 500gms
- ✓ Shellac, Blonde, De-Waxed, Flake, 1 kilo
- ✓ Shellac, Blonde, De-Waxed, Flake, 5 kilo

C2411	10.69	9.72
C2412	19.44	17.67
C2413	32.66	29.69
C2414	163.28	148.43
C2421	22.89	20.81
C2422	41.63	37.84
C2423	69.93	63.57
C2424	349.65	317.86
C2431	21.31	19.38
C2432	38.75	35.23
C2433	65.10	59.18
C2434	325.50	295.91
C2441	22.69	20.63
C2442	41.25	37.50
C2443	69.30	63.00
C2444	346.50	315.00
C2461	23.65	21.50
C2462	43.00	39.09
C2463	72.24	65.67
C2464	361.20	328.36

Orange



Button



Garnet



Ruby



Blonde



- ✓ Shellac, White, Waxy, Granulated, 250gms
- ✓ Shellac, White, Waxy, Granulated, 500gms
- ✓ Shellac, White, Waxy, Granulated, 1 kilo
- ✓ Shellac, White, Waxy, Granulated, 5 kilo

C2491	23.58	21.44
C2492	42.88	38.98
C2493	72.03	65.48
C2494	360.15	327.41
C2501	21.62	19.66
C2502	39.31	35.74
C2503	66.05	60.04
C2504	330.23	300.20

De-Waxed & Waxy White



- ✓ Shellac, White, De-Waxed, Granulated, 250gms
- ✓ Shellac, White, De-Waxed, Granulated, 500gms
- ✓ Shellac, White, De-Waxed, Granulated, 1 kilo
- ✓ Shellac, White, De-Waxed, Granulated, 5 kilo

READY MIX - supplied in Dangerous Goods Packaging

REGULAR FRENCH POLISH

- ✓ Orange, Ready Mixed, 1 litre DG Packed
- ✓ Orange, Ready Mixed, 5 litre DG Packed
- ✓ Waxy White, Ready Mixed, 1 litre DG Packed
- ✓ Waxy White, Ready Mixed, 5 litre DG Packed
- ✓ De Waxed White, Ready Mixed, 1 litre DG Packed
- ✓ De Waxed White, Ready Mixed, 5 litre DG Packed
- ✓ Blonde, Dewaxed, Ready Mixed, 1 litre DG Packed
- ✓ Blonde, Dewaxed, Ready Mixed, 5 litre DG Packed

C2510	35.34	32.13
C2511	102.72	93.38
C2513	57.71	52.46
C2514	173.01	157.28
C2516	49.83	45.30
C2517	148.26	134.78
C2522	64.01	58.19
C2523	192.81	175.28

French Polish



HARD FRENCH POLISH

- ✓ Orange, Ready Mixed, HARD, 1 litre DG Packed
- ✓ Orange, Ready Mixed, HARD, 5 litre DG Packed
- ✓ Waxy White, Ready Mixed, HARD, 1 litre DG Packed
- ✓ Waxy White, Ready Mixed, HARD, 5 litre DG Packed
- ✓ De Waxed White, Ready Mixed, HARD, 1 litre DG Packed
- ✓ De Waxed White, Ready Mixed, HARD, 5 litre DG Packed
- ✓ Blonde, Dewaxed, Ready Mixed, HARD, 1 litre DG Packed
- ✓ Blonde, Dewaxed, Ready Mixed, HARD, 5 litre DG Packed

C2526	123.54	112.31
C2527	379.92	345.38
C2529	145.91	132.64
C2530	450.21	409.28
C2532	138.03	125.48
C2533	425.46	386.78
C2538	88.11	80.10
C2539	359.91	327.19

Pure Tung Oil

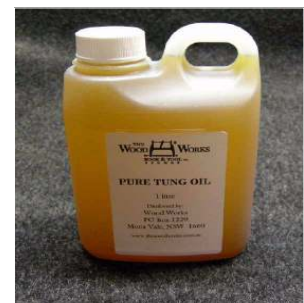

FINISHING OILS & WAXES

Our tung oil is pure whereas most formulations marketed as tung oil contain only a small amount of tung oil. Tung oil is non toxic, applicable for use as a finish on kitchen utensils and children's toys.

- ✓ Oil, Tung, Pure, 1 Litre
- ✓ Oil, Tung, Pure, 5 Litre
- ✓ Wax, Bees, Mirowax 738, 230gms (re-packed)
- ✓ Wax, Bees, 3 kilos

C2891	45.94	41.76
C2893	172.44	156.76
C7035	19.45	17.68
C7037	194.55	176.86

VELCRO HOOK STARTER PADS

- ✓ 200mm, Pressure Sensitive Adhesive Backing
- ✓ 230mm, Pressure Sensitive Adhesive Backing
- ✓ 250mm, Pressure Sensitive Adhesive Backing
- ✓ 280mm, Pressure Sensitive Adhesive Backing
- ✓ 300mm, Pressure Sensitive Adhesive Backing
- ✓ 350mm, Pressure Sensitive Adhesive Backing

A4138	9.29	8.45
A4139	15.68	14.25
A4140	20.01	18.20
A4141	26.40	24.00
A4142	29.70	27.00
A4143	33.53	30.48

Beeswax



ABRASIVE DISCS - VELCRO BACKED

- ✓ 10 discs, 250mm, 40grit
- ✓ 10 discs, 250mm, 60grit
- ✓ 10 discs, 250mm, 80grit
- ✓ 10 discs, 250mm, 120grit & finer
- ✓ 10 discs, 300mm, 40grit
- ✓ 10 discs, 300mm, 60grit
- ✓ 10 discs, 300mm, 80grit
- ✓ 10 discs, 300mm, 120grit & finer
- ✓ 10 discs, 350mm, 40grit
- ✓ 10 discs, 350mm, 60grit
- ✓ 10 discs, 350mm, 80grit
- ✓ 10 discs, 350mm, 120grit & finer

D3315	43.80	39.82
D3316	39.60	36.00
D3317	38.40	34.91
D3318	38.40	34.91
D3323	57.60	52.36
D3324	55.60	50.55
D3325	53.20	48.36
D3326	54.20	49.27
D3331	83.20	75.64
D3332	80.40	73.09
D3333	77.40	70.36
D3334	78.80	71.64



BOOKS

- | | | | |
|--|--------------|--------------|--------------|
| ✓ Wood in Australia - Types, Properties and Uses | B1455 | 94.95 | 86.32 |
|--|--------------|--------------|--------------|
- The revised, comprehensive reference on timbers used commercially in Australia. Timber technology and species description. Tables on moisture meter figures and mechanical properties of around 360 species of wood. Indispensable Australian technical reference. continuously in print since 1983. Anyone who works with wood in Australia will find this their bible.
Soft cover, 450 pages
-
- | | | | |
|-----------------------------|--------------|--------------|--------------|
| ✓ Roof Building Manual, The | B0183 | 25.95 | 23.59 |
|-----------------------------|--------------|--------------|--------------|
- Australian written soft cover manual for stick built roof cutting, one of the most mystifying aspects of all the carpentry trades. Contains step by step instructions and over 60 pages of templates.

